

MADER®

TRABALHA COMO
UM **PROFISSIONAL**

MADER®

**HAND
TOOLS**

- » ALICATES | ALICATE | PLIER
- » TESOURA LATOEIRO | TIJERA CORTA CHAPA | AVIATION PLIER
- » CORTA TUBOS | CORTATUBOS | PIPE CUTTER
- » ALICATE MULTICAMADA | PRENSA MANUAL-MULTICAPA | MANUAL PRESS PIPE TOOL
- » CHAVE STILSON | LLAVE TIPO STILSON | STILSON PIPE WRENCH
- » CHAVE CRESCENTE | LLAVE AJUSTABLE | ADJUSTABLE WRENCH
- » EXTRATOR PARAFUSOS | EXTRACTOR TORNILLOS | SCREW EXTRACTOR
- » MACHOS E CANÇONETES | MACHOS Y COJINETES | TAP AND DIE SET
- » CHAVE BOCA-LUNETA | LLAVE COMBINADA | COMBINATION SPANNER
- » CHAVE PARAFUSOS | DESTORNILLADORES | SCREWDRIVER
- » CHAVE DE CAIXA | LLAVES DE VASO | SOCKET TOOL SET
- » MALAS FERRAMENTA SORTIDA | CAJA HERRAMIENTA SURTIDA | ASSORTED HAND TOOL SET
- » VENTOSAS | VENTOSA | SUCTION PAD
- » BANDEJA BORRACHA | BANDEJA GOMA | RUBBER TOOL TRAY
- » O'RINGS | JUNTAS DE GOMA
- » GUIA ELETRICISTA | GUÍA ELECTRICISTA | FISH TAPE
- » MULTIMETRO | MULTIMETER
- » TORNOS | TORNILLOS DE BANCO | BENCH VICE
- » MARTELOS | MARTILLOS | HAMMERS
- » SERROTES | SERRUCHOS | SAWS
- » LIMAS | LIMAS | FILES
- » LIXAS | LIJAS | SANDING PAPERS
- » FACA ALCATIFA | CORTADOR | UTILITY KNIFE
- » MÁQUINAS AGRAFAR | GRAPADORA | STAPLE GUN
- » FITAS MÉTRICAS | FLEXÓMETRO | MEASURING TAPE » PAQUÍMETRO | CALIBRADOR | VERNIER CALIPER
- » NÍVEIS | NIVELES | LEVELS
- » ESQUADROS E RÉGUAS | ESCUADROS Y REGLAS | SQUARE AND RULERS
- » GRAMPOS APERTO | TORNILLO APRIETE | CLAMP
- » PISTOLA ESPUMA | PISTOLA ESPUMA | FOAM GUN
- » MÁQ. MASTIQUE | PISTOLA CARTUCHOS | CAULKING GUN
- » JOELHEIRAS | RODILLERA | KNEE PAD
- » MÁQUINA AZULEJOS | CORTADOR AZULEJOS | TILE CUTTERS
- » BETUMADEIRAS | ESPÁTULAS | SCRAPERS
- » COLHERES | PALETAS | TROWELS
- » TALOCHAS | LLANA | TROWELS
- » MARCADOR RETAS | CORDEL DE TRAZADO | CHALK LINE REEL » FIO PRUMO | HILO PLOMADA | PUMB-LINE
- » GAMELAS » BALDES | BANDEJAS » CUBOS | TRAYS » BUCKETS

Este catálogo apresenta a nossa gama atual. Mudanças no fabrico, forma, design e descrições dos artigos são atualizadas constantemente e pode ser verificado pela versão indicada na pág.. Fotos, descrições e especificações técnicas foram reproduzidas com a maior exatidão possível, sendo possíveis pequenas alterações do original. Os preços constantes no catálogo podem ser alterados sem aviso prévio, devido a alterações de características, aumentos na origem ou diferenças cambiais

Este catálogo presenta nuestra gama actual. Los cambios en la fabricación, los diseños y las descripciones de los artículos se actualizan constantemente y se pueden comprobar en la versión indicada en la pag. . Fotos, descripciones y especificaciones técnicas han sido reproducidos con la máxima exactitud, siendo posibles pequeños cambios en el original. Los precios en el catálogo pueden cambiar sin previo aviso debido a cambios en las características, aumentos en el origen o diferencias cambial.

ALICATE PARA BUCHA METAL ALICATE PARA BUJE METÁLICO METAL BUSHING PLIER

para Gesso Cartonado
para Placa de Yeso
for Plasterboard



21 un
150 mm

5 un - M4 x 21 mm
5 un - M4 x 32 mm
5 un - M4 x 38 mm
5 un - M4 x 46 mm

N. Ref.	Descrição	Marca	Quant. Caixa
61284	ALICATE P/BUCHAS-MHT-MET/GESSO	MADER HAND TOOLS	8/16

ALICATE REBITAR REMACHADORA RIVETING PLIER

TIPO TESOURA | TIPO DE TIJERA | SCISSOR TYPE



Rebites /Remanches /Rivets
Alumínio /Aluminio /Aluminium
2,4 - 3,2 - 4,0 - 4,8 - 6,4mm
Inox /Stainless Steel: 2,4 - 3,2 - 4,0 - 4,8m



61291

Descrição:	Alicate Rebitar		
Marca:	Mader Hand Tools		
N. Ref.	Especificação	Quant. Caixa:	
61291	Tipo Tesoura	1/20	

ALICATE REBITAR REMACHADORA RIVETING PLIER



61290



ALUMÍNIO
ALUMINIUM



61287



61289

CABEÇA GIRATÓRIA CABEÇA GIRATORIA SWIVEL HEAD



61288

Descrição: Alicate Rebitar
Marca: Mader Hand Tools

N. Ref.	Especificação	Quant. Caixa:
61290	DY-8113	6/24
61287	DY-8109 - Alumínio	6/24
61289	DY-8112 - Alumínio	6/24
61288	Cabeça Giratória	6/24

Rebites /Remanches /Rivets :
Alumínio /Aluminio /Aluminium:
 2,4 - 3,2 - 4,0 - 4,8mm
Inox /Stainless Steel:
 2,4 - 3,2 - 4,0mm

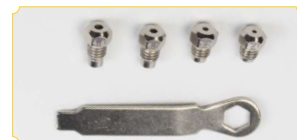

ALICATE REBITAR PORCAS REMACHADORA TUERCA NUT RIVETING PLIER



5 UN

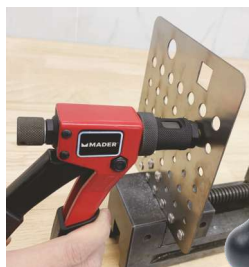

200mm
M3 - M6



Tamanho /Tamaño /Size: 200mm
Curso /Working Stroke: 7mm
Adaptadores /Adapters: M3, M4, M5, M6
Chave /Llave /Spaner: 1 un



8 UN



270mm
M3 - M12

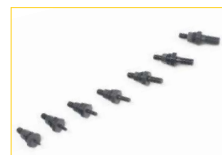

Tamanho /Tamaño /Size: 270mm
Curso /Working Stroke: 7mm
Adaptadores /Adapters: M3, M4, M5, M6, M8, M10, M12
Chave /Llave /Spaner: 1 un



78 UN



360mm
M3 - M12

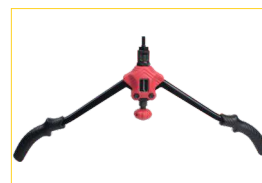
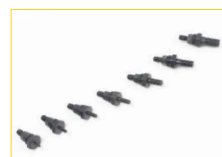

Tamanho /Tamaño /Size: 360mm
Curso /Working Stroke: 7mm
Adaptadores /Adapters: M3, M4, M5, M6, M8, M10, M12
Porca de Rebite /Tuerca de Remanche /Nut Rivets: M3 (x10), M4 (x10), M5 (x10), M6 (x10), M8 (x10), M10 (x10), M12 (x10)
Chave /Llave /Spaner: 1 un

Descrição: Alicate Rebitar Porcas

Marca: Mader Hand Tools

N. Ref.	Especificação	Quant. Caixa:
61292	M3-M6 - 5 un	5/20
61293	M3-M12 - 8 un	1/10
61294	M3-M12 - 78 un	6



PORCAS DE REBITE
TUERCA DE REMACHE
RIVET NUTS



M3x9

40un



M4x11

35un



M5x13

25un



M6x15

25un



M8x18

15un



M10x21

10un



M12x21

10un



Descrição: Porca de Rebite

Marca: Mader Hand Tools

N. Ref.	Especificação	Quant. Caixa:
61540	M3 x 9 - 40un	15/30
61541	M4 x 11 - 35un	15/30
61542	M5 x 13 - 25un	15/30
61543	M6 x 15 - 25un	15/30
61544	M8 x 18 - 15un	15/30
61545	M10 x 21 - 10un	15/30
61546	M12 x 21 - 10un	15/30

PORCAS DE REBITE TUERCA DE REMACHE RIVET NUTS



M3 - M10
150 UN

Tamanhos /Tamaños /Sizes:

40 un:	M3 x 9
35 un:	M4 x 11
25 un:	M5 x 13
25 un:	M6 x 15
15 un:	M8 x 18
10 un:	M10 x 21



Descrição: Porca de Rebite

Marca: Mader Hand Tools

N. Ref. Especificação
61309 M3-M10 - 150 un

Quant. Caixa:
5/25

ADAPTADOR » ALICATE REBITAR PORCAS ADAPTADOR » REMACHADORA TUERCA ADAPTER » NUT RIVETING PLIER



M3

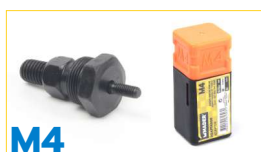

M4

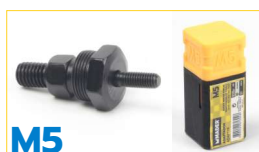

M5



M6



M8



Descrição: Adaptador » Alicate Rebitar Porcas

Marca: Mader Hand Tools

N. Ref. Especificação

61302	M3	1/25
61303	M4	6/25
61304	M5	6/25
61305	M6	6/25
61306	M8	6/25
61307	M10	6/25
61308	M12	6/25



M10



M12



ALICATE ALICATE PLIER

Revestido
Coated

CHROME VANADIUM

UNIVERSAL

160 mm

180 mm

200 mm



160 mm

180 mm

CORTE LATERAL
CORTE DIAGONAL
DIAGONAL CUT



160 mm

PONTA REDONDA
PUNTA REDONDA
ROUND NOSE



160 mm

200 mm

PONTA DIREITA
PUNTA RECTA
LONG NOSE



200 mm

PONTA CURVA
PUNTA CURVA
BENT NOSE

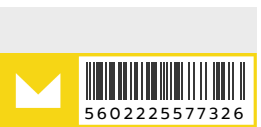

N. Ref.	Descrição	Marca	Quant. Caixa
57720	ALICATE UNIV-MGL-160MM 62331	MADER HAND TOOLS	6/60
57722	ALICATE UNIV-MGL-180MM 62332	MADER HAND TOOLS	6/60
57724	ALICATE UNIV-MGL-200MM 62333	MADER HAND TOOLS	6/60
57735	ALICATE C/LAT-MHT-160MM 53621B	MADER HAND TOOLS	6/60
57737	ALICATE C/LAT-MGL-180MM	MADER HAND TOOLS	6/60
57726	ALICATE P/RED-MGL-160MM 62338	MADER HAND TOOLS	6/60
57728	ALICATE P/DTA-160MM 62339	MADER HAND TOOLS	6/60
57730	ALICATE P/DTA-MGL-200MM 62340	MADER HAND TOOLS	6/60
57732	ALICATE P/CURVA-MGL-200MM62342	MADER HAND TOOLS	6/60



ALICATE
ALICATE
PLIER

CHROME VANADIUM

Revestido
Coated

DESCARNAR FIO
PELACABLES WIRE
STRIPPING



160 mm



N. Ref.	Descrição	Marca	Quant. Caixa
57738	ALICATE DESCAR-MGL-160MM 62349	MADER HAND TOOLS	6/60

TURQUEZ
TENAZA
PINCERS

CHROME VANADIUM

Revestido
Coated



225 mm

250 mm



N. Ref.	Descrição	Marca	Quant. Caixa
61090	TURQUEZ-MHT-225MM - CRV-9"	MADER HAND TOOLS	6/48
61091	TURQUEZ-MHT-250MM - CRV-10"	MADER HAND TOOLS	6/48

ALICATE
ALICATE
PLIER

CHROME VANADIUM

Revestido
Coated

BOMBA D' ÁGUA
PICO LORO
WATER PUMP

250 mm

300 mm



N. Ref.	Descrição	Marca	Quant. Caixa
57768	ALICATE B/ÁGUA-MGL-250MM-D4-10"	MADER GOLD	6/36
57769	ALICATE B/ÁGUA-MGL-300MM-A6-12"	MADER GOLD	6/36

ALICATE FIXAÇÃO / PRESSÃO

ALICATE MORDAZA
LOCK WRENCH PLIER

CHROME VANADIUM



250 mm

Tipo de Ponta: Curva
Abertura max.: 45 mm
Tipo de Ponta: Curva
Apertura max.: 45 mm
Tip Type: Curved
Opening max.: 45 mm

N. Ref.	Descrição	Marca	Quant. Caixa
61297	ALICATE FIXAÇÃO-MHT-250MM CR-V	MADER HAND TOOLS	7

ALICATE FIXAÇÃO / PRESSÃO

ALICATE MORDAZA
LOCK WRENCH PLIER



com Bolsa
with Pouch



4 un

4 un » 125 - 165 - 175 - 250 mm

N. Ref.	Descrição	Marca	Quant. Caixa
61295	ALICATE FIXA-MHT-4PCS AÇO CARB	MADER HAND TOOLS	6/12

ALICATES ALICATES PLIERS

Universal:
1 un - 175 mm
Ponta Direita | Punta Recta | Straight Tip:
1 un - 175 mm
Corte Lateral | Side Cut:
1 un - 175 mm



3 un
175 mm



N. Ref.	Descrição	Marca	Quant. Caixa
52133	ALICATE SORT-MPL-7" 3PC	MADER HAND TOOLS	5/30

ALICATE BOMBA DE ÁGUA ALICATE PICO LORO WATER PUMP PLIER

com Bolsa
with Pouch



3 un



N. Ref.	Descrição	Marca	Quant. Caixa
57775	ALICATE B/ÁGUA-MHT-3PÇS AÇO CA	MADER HAND TOOLS	6/12

3 un » 175 - 250 - 300 mm

ALICATE MULTIFUNÇÕES
ALICATE MULTIFUNCIONES
MULTIFUNCTION PLIER

X-ATO
CORTADOR
KNIFE



Alicate Multifunções | Alicate Multifunción
| Multifunction Plier: 1 un
Bolsa de Nylon | Bolsa de Nylon | Nylon Bag: 1 un
X-Ato Desdobrável | Cortador Despegable
| Folding Knife: 1 un
Lâminas | Láminas | Blades: 5 un

N. Ref.	Descrição	Marca	Quant. Caixa
57776	ALICATE MULTI FUNÇ-MHT-C/X-ATO	MADER HAND TOOLS	12/48

ALICATE MULTIFUNÇÕES
ALICATE MULTIFUNCIONES
MULTIFUNCTION PLIER

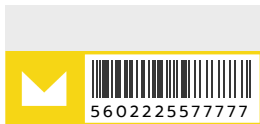

5 IN 1

Alicate | Plier:
- Terminais | Terminales | Crimping
1.5 - 6 mm
- Descarnar Fio | Pela Cables | Wire Stripper
0.6 - 2.6 mm
- Corte | Corte | Cut
- Latoeiro | Corta Chapa | Aviation
- Universal

N. Ref.	Descrição	Marca	Quant. Caixa
57777	ALICATE MULTI FUNÇ-MHT-5EM1	MADER HAND TOOLS	12

TESOURA LATOEIRO
TIJERA CORTA CHAPA
AVIATION PLIER

CHROME VANADIUM



FRENTE
DELANTERO
STRAIGHT



DIREITA
DERECHA
RIGHT CUT



ESQUERDA
IZQUIERDA
LEFT CUT



250mm



250mm



250mm

Descrição: **Tesoura Latoeiro**

Marca: **Mader Hand Tools**

N. Re	Especificação	Quant. Caixa:
61281	Corte Frente - 250 mm	6/50
61283	Corte Direita - 250 mm	10/50
61282	Corte Esquerda - 250 mm	10/50

ESCAREADOR TIPO CANETA ESCARIADOR LAPICERA PEN REAMER



5 LÂMINAS
CUCHILLAS
BLADES



CORTA TUBOS CORTATUBOS PIPE CUTTER



32mm

Descrição: Escareador tipo Caneta / Corta Tubos

Marca: Mader Hand Tools

N. Ref.	Especificação	Quant.	Caixa:
61455	5 Lâminas	1/24	70
56590	Inox - 32 mm		

CABEÇA » ALICATE para MULTICAMADA CABEZA » PRENSA MANUAL para MULTICAPA HEAD » MANUAL PRESS PIPE TOOL

para **57899**



16mm



20mm



25mm



32mm

Descrição: Cabeça p/ Alicate Multicamada - 57899

Marca: Mader Hand Tools

N. Ref.	Especificação	Quant.	Caixa:
57696	16 mm	1	
57697	20 mm	1	
57698	25 mm	1	
57699	32 mm	1	



CABEÇA » ALICATE para MULTICAMADA CABEZA » PRENSA MANUAL para MULTICAPA HEAD » MANUAL PRESS PIPE TOOL

para **58060**



12mm



16mm



20mm



25mm

Descrição: Cabeça p/ Alicate Multicamada - 58060

Marca: Mader Hand Tools

N. Ref.	Especificação	Quant.	Caixa:
58061	12 mm	1	
58062	16 mm	1	
58063	20 mm	1	
58064	25 mm	1	



ALICATE MULTICAMADA
PRENSA MANUAL MULTICAPA
MANUAL PRESS MULTILAYER PLIER



4

matrizes | matrices | Dies:
12, 16, 20, 25 mm



1 Mala Transporte Plástica
1 Maletín Transporte Plástico
1 Plastic Transport Bag

N. Ref.	Descrição	Marca	Quant. Caixa
58060	ALICATE P/MULTICAM-MHT-12-25MM	MADER HAND TOOLS	5/20

ALICATE MULTICAMADA
PRENSA MANUAL MULTICAPA
MANUAL PRESS MULTILAYER PLIER

CHROME VANADIUM

Matrizes com Encaixe Rápido
Matrices de Montaje Rápido
Quick-fit Dies



Extensível: 350 - 580 mm
Extensible: 350 - 580 mm
Extensive: 350 - 580 mm

Contém / Contiene / Contains	4 matrizes:
	16, 20, 25, 32mm

1 Mala Transporte Plástica
1 Maletín Transporte Plástico
1 Plastic Transport Bag

N. Ref.	Descrição	Marca	Quant. Caixa
57899	ALICATE P/MULTICAMADA-MHT-5PCS	MADER HAND TOOLS	4

CHAVE STILSON LLAVE TIPO STILSON STILSON PIPE WRENCH

Cabo revestido
Mango recubierto
Coated handle



250 mm **10"** 300 mm **12"** 350 mm **14"**



450 mm **18"** 600 mm **24"** 900 mm **36"** 1200 mm **48"**



N. Ref.	Descrição	Marca	Quant. Caixa
57712	CH STILSON-MHT-101025-10" ISOL	MADER HAND TOOLS	6/12
57713	CH STILSON-MHT-101030-12" ISOL	MADER HAND TOOLS	4/16
57714	CH STILSON-MHT-101035-14" ISOL	MADER HAND TOOLS	2/12
57715	CH STILSON-MHT-101045-18" ISOL	MADER HAND TOOLS	2/4
57716	CH STILSON-MHT-101060-24" ISOL	MADER HAND TOOLS	4/6
57717	CH STILSON-MGL-101090-36" ISOL	MADER GOLD	2
57718	CH STILSON-MHT-101120-48" ISOL	MADER HAND TOOLS	2

350 mm **14"** 450 mm **18"** 600 mm **24"**



Alumínio
Aluminio
Aluminum

N. Ref.	Descrição	Marca	Quant. Caixa
88820	CH STILSON-MHT-14" ALUMINIO	MADER HAND TOOLS	1/6
88821	CH STILSON-MHT-18" ALUMINIO	MADER HAND TOOLS	1/6
88822	CH STILSON-MHT-24" ALUMINIO	MADER HAND TOOLS	1/6



CHAVE TIPO SUECO LLAVE TIPO SUECA SWEDISH PIPE WRENCH

CHROME VANADIUM



1" **1.1/2"** **2"**
25 mm 38 mm 50 mm



N. Ref.	Descrição	Marca	Quant. Caixa
57748	CH T/SUECO-MGL-61011-1"	MADER HAND TOOLS	10/20
57750	CH T/SUECO-MGL-61012-1.1/2"	MADER HAND TOOLS	6/12
57752	CH T/SUECO-MGL-61013-2"	MADER HAND TOOLS	6/14



CHAVE CRESCENTE
LLAVE AJUSTABLE
ADJUSTABLE WRENCH

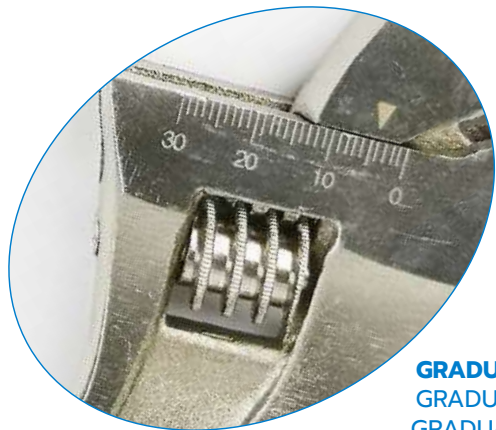

GRADUADA
GRADUADO
GRADUATED

CABO REVESTIDO
MANGO RECUBIERTO
DIPPING HANDLE



Descrição: Chave Crescente

Marca: Mader Hand Tools

N. Ref. Especificação

61190 Borracha - 200mm

61191 Borracha - 250mm

61192 Borracha - 300mm"

Quant. Caixa:

6/120

6/60

6/80



8"
200mm



10"
250mm



12"
300mm

CHAVE COM CORRENTE
LLAVE DE CADENA
CHAIN WRENCH



610mm

Descrição: Chave c/ Corrente

Marca: Mader Hand Tools

N. Ref. Especificação

57762 610 mm

Quant. Caixa:

20

MACHOS E CAÇONETES

MACHOS Y COJINETES

TAP AND DIE SET



13 un



5602225630755

Machos | Machos | Tap : 6 un
 - M3x0.5, M4x0.7, M5x0.8, M5x0.9, M6x1.0, M8x1.25
 Caçonetes | Cojinetes | Die: 6 un
 - M3x0.5, M4x0.7, M5x0.8, M5x0.9, M6x1.0, M8x1.25
 Chave | Llave | Wrench: 1 un

N. Ref.	Descrição	Marca	Quant. Caixa
63075	MACHO/CANÇONETO-MPT-JG 13PC	MADER POWER TOOLS	1/10

MACHOS E CAÇONETES

MACHOS Y COJINETES

TAP AND DIE SET



25 un



5602225630762

Machos | Machos | Tap : 12 un
 - 5/16NC18, 1/4NC20, 12NC24, 10NC24, 8NC32, 6NC32, M3x0.5, M4x0.7, M5x0.8, M5x0.9, M6x1.0, M8x1.25
 Caçonetes | Cojinetes | Die: 12 un
 - 5/16NC18, 1/4NC20, 12NC24, 10NC24, 8NC32, 6NC32, M3x0.5, M4x0.7, M5x0.8, M5x0.9, M6x1.0, M8x1.25
 Chave | Llave | Wrench: 1 un

N. Ref.	Descrição	Marca	Quant. Caixa
63076	MACHO/CANÇONETO-MPT-JG 25PC	MADER POWER TOOLS	1/10

DESANDADOR PARA CAÇONETES

TERRAJA DE COJINETES

ROUND HANDLE FOR DIES



5602225630793

1"

N. Ref.	Descrição	Marca	Quant. Caixa
63079	DESANDADOR CAÇONETE-MPT-1"	MADER POWER TOOLS	10/60

MACHOS E CAÇONETES

MACHOS Y COJINETES

TAP AND DIE SET



61118

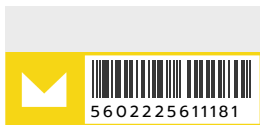

5602225611181

20 un

Machos | Machos | Tap : 9 un
 - M3x0.5, M4x0.7, M5x0.8, M6x1.0, M7x1.0, M8x1.25, M9x1.25, M10x1.5, M12x1.75
 Caçonetes | Cojinetes | Die: 9 un
 - M3x0.5, M4x0.7, M5x0.8, M6x1.0, M7x1.0, M8x1.25, M9x1.25, M10x1.5, M12x1.75
 Desandador | Terraça | Wrench: 2 un
 Machos | Machos | Tap : M3 - M12
 Caçonetes | Cojinetes | Die: 25 mm

N. Ref.	Descrição	Marca	Quant. Caixa
61118	MACHOS/CAÇONETES-MHT-20UN	MADER HAND TOOLS	24

MACHOS E CAÇONETES

MACHOS Y COJINETES

TAP AND DIE SET



61106



5602225611068

32 un

Machos | Machos | Tap : 21 un
 Cónico|Conico|Taper
 - M3x0.5, M4x0.7, M5x0.8, M6x1.0, M8x1.25, M10x1.5, M12x1.75
 Ponto|Punto|Pulg
 - M3x0.5, M4x0.7, M5x0.8, M6x1.0, M8x1.25, M10x1.5, M12x1.75
 Direito|Derecho|Bottom
 - M3x0.5, M4x0.7, M5x0.8, M6x1.0, M8x1.25, M10x1.5, M12x1.75
 Caçonetes | Cojinetes | Die: 7 un
 - M3x0.5, M4x0.7, M5x0.8, M6x1.0, M8x1.25, M10x1.5, M12x1.75
 Desandador | Terraça | Wrench: 2 un
 Machos | Machos | Tap : M3 - M12
 Caçonetes | Cojinetes | Die: 25 mm
 Chave | Llave | Wrench: 1 un
 Escartilhão de Roscas | Patrón Roscas
 | Screwdriver Pitch Gauge: 1 un

N. Ref.	Descrição	Marca	Quant. Caixa
61106	MACHOS/CAÇONETES-MHT-32 PEÇAS	MADER HAND TOOLS	1/10

DESANDADOR PARA MACHOS

TERRAJA DE MACHOS

ROUND HANDLE FOR TAPS



63077



5602225630779

1/2"



63078



5602225630786

1"

N. Ref.	Descrição	Marca	Quant. Caixa
63077	DESANDADOR MACHO-MPT-1/2"	MADER POWER TOOLS	1/50
63078	DESANDADOR MACHO-MPT-1"	MADER POWER TOOLS	5/20

CHAVE 2 BOCAS LLAVE 2 BOCAS DOUBLE OPEN END SPANNER

PROFISSIONAL CHROME VANADIUM



6mm x 7mm



8mm x 9mm



10mm x 11mm



12mm x 13mm



14mm x 15mm



16mm x 17mm



18mm x 19mm



20mm x 22mm

Descrição: Chave 2 Bocas
Marca: Mader Hand Tools

N. Ref.	Especificação	Quant. Caixa:
57862	6 x 7 mm	25/100
57866	8 x 9 mm	40/150
57868	10 x 11 mm	50/300
57870	12 x 13 mm	40/90
57872	14 x 15 mm	25/100
57874	16 x 17 mm	25/100
57876	18 x 19 mm	25/100
57878	20 x 22 mm	20/70
57880	21 x 23 mm	15/60
57882	24 x 26 mm	10/40
57883	24 x 27 mm	50/60
57884	25 x 28 mm	50/50
57888	30 x 32 mm	5/40



21mm x 23mm



24mm x 26mm



24mm x 27mm



25mm x 28mm



30mm x 32mm



8un

6x7, 8x9, 10x11, 12x13,
14x15, 16x17, 18x19,
20x22 mm



12un

6x7, 8x9, 10x11, 12x13,
14x15, 16x17, 18x19,
20x22, 21x23, 24x26,
25x28, 30x32 mm

Descrição: Chaves 2 Bocas
Marca: Mader Hand Tools

N. Ref.	Especificação	Quant. Caixa:
59550	8 un	20
59551	12 un	2/10



CHAVE LUNETA LLAVE ACODADA DOUBLE RING SPANNER

PROFISSIONAL CHROME VANADIUM



6mm x 7mm



8mm x 9mm



10mm x 11mm



12mm x 13mm



14mm x 15mm



16mm x 17mm



18mm x 19mm



20mm x 22mm

Descrição: Chave Luneta

Marca: Mader Hand Tools

N. Ref.	Especificação	Quant. Caixa:
57786	6 x 7 mm	1
57788	8 x 9 mm	25/50
57790	10 x 11 mm	10/120
57792	12 x 13 mm	20/80
57794	14 x 15 mm	20
57796	16 x 17 mm	15/60
57798	18 x 19 mm	50
57800	20 x 22 mm	10/50
57802	21 x 23 mm	10/20
57804	24 x 26 mm	50
57806	25 x 28 mm	25
57808	27 x 29 mm	25
57810	30 x 32 mm	25



21mm x 23mm



24mm x 26mm



25mm x 28mm



27mm x 29mm



30mm x 32mm



8un

6x7, 8x9, 10x11, 12x13,
14x15, 16x17,
18x19, 20x22 mm



12un

6x7, 8x9, 10x11, 12x13,
14x15, 16x17, 18x19,
20x22, 21x23, 24x26,
25x28, 30x32 mm

Descrição: Chaves Luneta

Marca: Mader Hand Tools

N. Ref.	Especificação	Quant. Caixa:
59558	8 un	15
59559	12 un	4



CHAVE BOCA-LUNETA
LLAVE COMBINADA
COMBINATION SPANNER



PROFISSIONAL
CHROME VANADIUM



12mm



16mm



6mm



9mm



13mm



17mm



7mm



10mm



14mm



18mm



8mm



11mm



15mm



19mm



20mm



23mm



26mm



29mm



21mm



24mm



27mm



30mm



22mm



25mm



28mm



32mm

Descrição: Chave Boca/Luneta

Marca: Mader Hand Tools

N. Ref.	Especificação	Quant. Caixa:
57812	6 mm	60
57814	7 mm	30
57816	8 mm	50/100
57818	9 mm	200
57820	10 mm	30/120
57822	11 mm	50/100
57824	12 mm	50/50
57826	13 mm	50/100
57828	14 mm	50/100
57830	15 mm	50/100
57832	16 mm	30/60
57834	17 mm	30/100
57836	18 mm	25/50
57838	19 mm	30
57840	20 mm	25/100
57842	21 mm	20/40
57844	22 mm	15/30
57846	23 mm	5/50
57848	24 mm	10/50
57850	25 mm	10/30
57852	26 mm	5/50
57854	27 mm	10/20
57856	28 mm	10
57858	29 mm	10
57860	30 mm	10/20
57861	32 mm	10/30

CHAVE BOCA-LUNETA LLAVE COMBINADA COMBINATION SPANNER

8un



8, 9, 10, 11, 13, 14,
17, 19 mm

PROFISSIONAL CHROME VANADIUM



12un

6, 7, 8, 9, 10, 11, 12, 13,
14, 17, 19, 22 mm



Descrição: Chaves Boca - Luneta

Marca: Mader Hand Tools

N. Ref. Especificação

59555 8 un

Quant. Caixa:

16/16

59556 12 un

10/10

CHAVE BOCA-LUNETA LLAVE COMBINADA COMBINATION SPANNER

C/ ROQUETE - ARTICULADO
C/ CARRACA - ARTICULADA
W/ RATCHET - REMOVABLE



7un

8, 10, 12, 13, 14, 17, 19mm



5un | CRV

8, 10, 13, 14, 17mm

Descrição: Chave Boca/Luneta c/ Roquete

Marca: Mader Hand Tools

N. Ref. Especificação

61299 Articulado - 7 un

Quant. Caixa:

1/12

61301 Articulado - 5 un

10/10



CHAVE PARAFUSOS DESTORNILLADORES SCREWDRIVER



CHROME VANADIUM

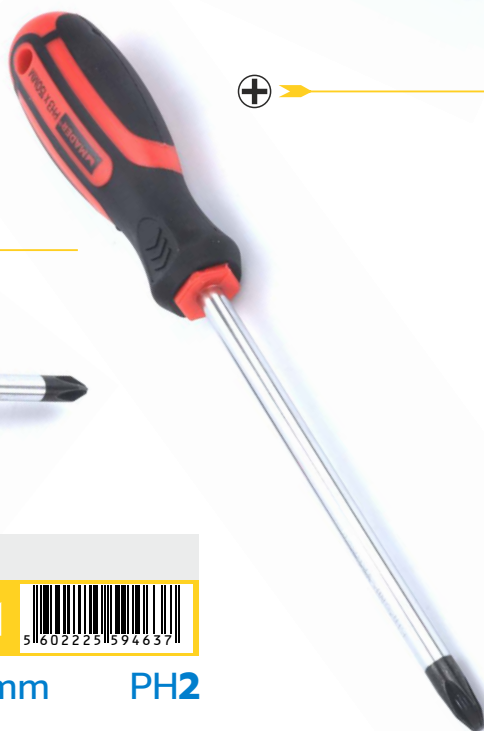

100mm PZ1



125mm PZ2



75mm PH0



100mm PH1



125mm PH2



150mm PH3



300mm PH2



400mm PH2



38mm PH1



38mm PH2



38mm 5.5mm



75mm 4mm



100mm 4mm



125mm 5.5mm



150mm 6.5mm



175mm 8mm



200mm 10mm



CR-MOBY

200mm 10mm

Descrição: Chave Parafusos CRV

Marca: Mader Hand Tools

N. Ref.	Especificação	Quant. Caixa:
59460	PZ1x100mm	12/120
59461	PZ2x125mm	12/120
59462	PH1x38mm	12/120
59463	PH2x38mm	12/120
59464	PH0x75mm	12/120
59465	PH1x100mm	12/120
59466	PH2x125mm	12/120
59467	PH3x150mm	12/120
59475	PH2x300mm	12
59476	PH2x400mm	8
59468	5.5x38mm	12/120
59469	4x75mm	12/120
59470	4x100mm	12/120
59471	5.5x125mm	12/120
59472	6.5x150mm	12/120
59473	8x175mm	12/120
59474	10x200mm	10/60
59406	10x200mm CR-MOLYBDENUM	1

CHAVE DE PARAFUSOS LLAVES DE DESTORNILLADORES SCREWDRIVER

Chrome-Vanadium



VDE
8 un

Chave Parafusos VDE | Destornillador VDE | VDE Screwdriver: **7 un**

Fenda | Plana | Flat:
SL3x0.5x75, SL4x0.8x100, SL5.5x1x125, SL6.5x1.2x150 mm
Philips | Philips | Philips:
PH0x75, PH1x80, PH2x100 mm

Chave Busca-Pólos | Buscapolos | Voltage Tester:
140 mm

N. Ref.	Descrição	Marca	Quant. Caixa
61185	CH PARAFUSOS-MHT-VDE 8PC	MADER HAND TOOLS	12

CHAVE BUSCA-PÓLOS DESTORNILLADOR NEON BUSCAPOLOS VOLTAGE TESTER SCREWDRIVER



140mm
AC - 100 - 500V



2un

Descrição: Chave Busca - Pólos
Marca: Mader Hand Tools

N. ef.	Especificação	Quant. Caixa:
83214	140 mm	20/500
83213	190 mm	20/500
83216	210 mm	20/500
83215	140 mm + 190 mm - 2 un.	25/200



190mm
AC-120-250V



210mm
AC-100-500V



140 + 190mm
AC-100-500V

CHAVE PARAFUSOS DESTORNILLADORES SCREWDRIVER

- ⊖ 3.0 x 75 mm
4.0 x 100 mm
5.0 x 125 mm
6.0 x 150 mm
8.0 x 200 mm
- ⊕ PH 0 x 75 mm
PH 0 x 100 mm
PH 1 x 125 mm
PH 2 x 150 mm



CHROME VANADIUM



9un



Descrição: Chave Parafusos Sortida

Marca: Mader Hand Tools

N. Ref. 52134 Especificação Cabo Borracha - 9 un

Quant. Caixa: 20

CHAVE PARAFUSOS DESTORNILLADORES SCREWDRIVER



10un



MAGNÉTICA
MAGNÉTICA
MAGNETIC



Descrição: Chave Parafusos

Marca: Mader Hand Tools

N. Ref. 61132 Especificação Vermelha/Preta - 10 un

Quant. Caixa: 25/25

- ⊖ 3 x 75 mm
4 x 100 mm
5 x 125 mm
6 x 100 mm
6 x 38 mm

- ⊕ PH 0 x 75 mm
PH 1 x 100 mm
PH 1 x 125 mm
PH 2 x 100 mm
PH 2 x 38 mm

EXTRATOR DE PARAFUSOS EXTRACTOR DE TORNILLOS SCREW EXTRACTOR



- 1/8" - 1/4
- 1/4" - 5/16
- 5/16" - 7/16
- 7/16" - 9/16
- 9/16" - 3/4



5un



Descrição: Extrator de Parafusos

Marca: Mader Hand Tools

N. Re 61110 Especificação 5un

Quant. Caixa: 25/100

MALA FERRAMENTA SORTIDA MALETIN DE HERRAMIENTA SURTIDA HAND TOOL SET



- 11un Chaves /Llaves /Wrench
- 4un Chaves Precisão /Llaves de Precisión /Precision Wrench
- 25un Bits /Puntas
- 18un Chaves Caixa /Llaves Vaso /Socket
- 1un Adaptador Bits /Adaptador Puntas /Bits Adapter
- 1un Extensão Flexível /Mango Articulado /Flexible Extension

60UN

Descrição: Mala Ferramenta Sortida

Marca: Mader Hand Tools

N. Re Especificação
52135 60 un

Quant. Caixa:
10/10



CHAVE SEXTAVADA + TORX LLAVE HEXAGONAL + TORX HEX + TORX KEY WRENCHES

CHROME VANADIUM



16 un



Descrição: Chave Sextavada + Torx

Marca: Mader Hand Tools

N. Ref. Especificação
61120 C.V. - 16 un

Quant. Caixa:
5

- ⦿ (75mm) E2, E2.5, (100mm) E3, E4, (150mm) E5, E6, (200mm) E8, E10 (SEXT)
- ⦿ (75mm) T10, T15, (100mm) T20, T25, (150mm) T30, T40, (200mm) T45, T50 (TORX) **COM FURO | CON ORIFICIO | WITH HOLE**

CHAVE TORX LLAVE TORX TORX KEY

COM ADAPTADOR
CON ADAPTADOR
WITH ADAPTER



9 un

T10, T15, T20, T25, T27, T30, T40, T45, T50

COM FURO
CON ORIFICIO
WITH HOLE



LONGAS /LARGAS /LONG

CHROME VANADIUM

CHAVE TORX LLAVE TORX TORX KEY



9 un

COM FURO
CON ORIFICIO
WITH HOLE

T10, T15, T20, T25,
T27, T30, T40, T45,
T50



CHAVE SEXTAVADA LLAVE HEXAGONAL HEX KEY WRENCHES



9 un

E15, E2, E2.5, E3, E4,
E5, E6, E8, E10

Descrição: Chave

Marca: Mader Hand Tools

N. Ref.	Especificação	Quant. Caixa:
57529	Torx c/ Adaptador - 9 un	10/40
61170	Torx Longa CRV - 9 un	10/50
61160	Sextavada Longa CRV - 9 un	12/60

KIT REPARAÇÃO - BICICLETA KIT REPARACIÓN - BICICLETAS REPAIR TOOL KIT - BICYCLE

Chave de Aperto /Llave Apriete /Spanner: 8, 10, 15mm
Chaves Caixa /Llaves Vaso /Sockets: - Hex: 8, 9, 10,mm
Adaptador Universal /Universal Adaptor
Chaves /Destronillador /Screwdrivers:
Plana-flat, Phillips, Hex 2, 2.5, 3, 4, 5, 6mm
Bolsa /Estuche /Storage Pouch
Espátula Pneus /Palanca Neumáticos /Tyre Levers
Tubo Cola /Tubo de Adhesivo /Glue
Remendos /Parches | Patches: 35x50, 25x35, 28x28mm

Descrição: Kit Bicicleta

Marca: Mader Hand Tools

N. Ref.	Especificação	Quant. Caixa:
16031	p/ Reparação	6/24

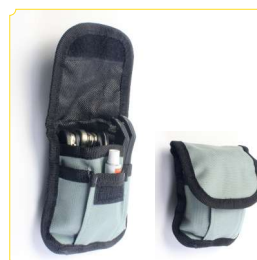

BITS PUNTAS BITS



25mm | 6un

CHROME MOLYBDENUM



⊕ PH1



⊕ PH2



⊕ PH3



⊛ T15



⊛ T20



⊛ T27



50mm | 6un



⊕ PH2



⊛ PZ1



⊛ PZ2



⊛ PZ3



⊛ PZ2

Descrição: Bits

Marca: Mader Hand Tools

N. Ref.	Especificação	Quant. Caixa:
61312	6 un - PH1 x 25mm	24/72
61313	6 un - PH2 x 25mm	24/72
61314	6 un - PH3 x 25mm	24/72
61315	6 un - T15 x 25mm	24/72
61316	6 un - T20 x 25mm	24/72
61317	6 un - T27 x 25mm	24/72
61318	6 un - PZ1 x 25mm	24/72
61319	6 un - PZ2 x 25mm	24/72
61320	6 un - PZ3 x 25mm	24/72
61310	6 un - PH2 x 50mm	24/72
61311	6 un - PZ2 x 50mm	24/72
57620	10 un - Torx - 50mm	12/72

TORX

CHROME VANADIUM



50mm
10un

⊛ T6, T7, T8, T9, T10, T15, T20, T25, T27, T30



BITS COM ADAPTADOR PUNTAS CON ADAPTADOR BITS WITH DRIVER

14 un



Composição / Composición / Composition	SL3, SL4, SL5, PH1, PH2, PH3, PZ1, PZ2, PZ3, T10, T15, T20, T25, T30
Acessórios / Accesorios / Accessories	Adaptador - 1 un

N. Ref.	Descrição	Marca	Quant. Caixa
61096	BIT'S SORT-MHT-15UN	MADER HAND TOOLS	50

BITS » CHAVES DE CAIXA
PUNTAS » LLAVES DE VASO
BITS » NUTSETTER

MAGNÉTICO | MAGNETIC



6mm **MAC**



7mm



8mm



9mm



10mm



11mm



12mm



13mm



6, 8, 10, 12mm
25mm | 4un



5, 6, 8, 10, 11, 13mm
25mm | 6un

Descrição: **Bits » Chaves de Caixa**

Marca: **Mader Hand Tools**

N. Ref.	Especificação	Quant. Caixa:
66580	6mm - Mac Power	50/100
61700	7mm	50
61701	8mm	10/200
61702	9mm	50
61703	10mm	10/200
61704	11mm	10/200
61705	12mm	10/200
61706	13mm	10/200

51192 4 un - 6, 8, 10, 12mm 10/60

51189 6 un - 5, 6, 8, 10, 11, 13mm 10/100

BITS PUNTAS BITS

ADAPTADOR MAGNÉTICO ADAPTADOR MAGNÉTICO MAGNETIC DRIVER

CHROME VANADIUM



26UN



Descrição: Bits
 Marca: Mader Hand Tools
 N. Ref. Especificação Quant. Caixa:
 61095 c/ Adaptador C.V. - 26 un 12/48

- ⊕ PH1 (x4), PH2 (x4), PH3 (x4)
- ⊗ PZ1 (x4), PZ2 (x4)
- ⊙ T8, T10, T15, T20, T25

BITS PUNTAS BITS

CHROME VANADIUM



- ⊖ 3, 4, 5, 6mm
- ⊕ PH0(x2), PH1(x2), PH2(x3), PH3(x2)
- ⊗ PZ0, PZ1(x2), PZ2(x3), PZ3(x2)
- ⊙ 15, 2, 2.5, 3, 4, 4.5, 5.5, 6mm, 1/16", 5/64", 3/32", 7/64", 1/8", 9/64", 5/32", 3/16", 7/32", 1/4"
- ⊙ 2, 2.5, 3, 4, 5, 6mm 5/64", 3/32", 7/64", 1/8", 9/64", 5/32"
- ⊙ T8, T10(x2), T15(x2), T20(x2), T25(x2), T27, T30, T40, T45
- ⊙ T8H, T10H, T15H, T20H, T25H, T27H, T30H, T40H, T45H
- ⊙ M5, M6, M8 ⊙ S0, S1, S2, S3
- ⊕ 6, 8, 10 ⊕ 1, 2, 3, 4
- ⊖ 4, 6, 8, 10 ⊕ C1, C2, C3

- 1un Roquete /Carraca /Ratchet
- 1un Extensão Magnético /Extensión Magnética /Magnetic Extension
- 1un Adapt. Chave Caixa /Adaptad. Llave Vaso /Socket Adapter
- 2un Adaptador Bits /Adapter Puntas /Bits Adapter 25, 50mm
- 1un Bit em Y /Punta en Y /Wing Adapter



101 UN
25mm

Descrição: Bits
 Marca: Mader Hand Tools
 N. Ref. Especificação Quant. Caixa:
 61102 Sortidos - C.V. - 101 un 10/10

ADAPTADORES

ADAPTADORES
ADAPTERS

3un Adapt. Chave Caixa | Adaptad. Llave Vaso |
Socket Adapter: 1/4", 3/8", 1/2"

3un Extensão Magnética | Extensión Magnética |
Magnetic Extension: 60, 100, 150mm

⊖ 5, 6mm ⊕ PH0, PH1, PH2(x2), PH3 ✱ PZ2 ◼ S1, S2



COM EXTENSÃO



16UN



⊖ 4, 6mm

⊕ PH1, PH2(x2)

✱ PZ1, PZ2



COM OSCILANTE



8UN

Descrição:	Adaptadores
Marca:	Mader Hand Tools
N. Ref.	Especificação
61720	Adaptador 16 un
61721	Adaptador 8 un
61725	Adaptador 6 un

Quant.	Caixa:
10/40	
10/40	
10/40	



COM EXTENSÃO

6UN



Adapt. Chave Caixa |
Adaptad. Llave Vaso |
Socket Adapter: 1/4", 3/8",
1/2"

Extensão Flexível |
Flexible Extension: 1/4" x
150mm

Adap. Encaixe Rápido |
Adaptador Conexión
Rápida | Quick Change
Adapter

Adaptador Magnético |
Adaptador Magnético |
Magnetic Adapter

CHAVE COM BITS DE PRECISÃO
LLAVE CON PUNTAS DE PRECISIÓN
SCREWDRIVER WITH PRECISION BITS

24IN1



Bits de precisão para eletrônica (PC's, Tablets, Smartphones)
 Puntas de precisión para electrónica (PC, Tablets, Smartphones)
 Precision bits for electronics (PCs, Tablets, Smartphones)

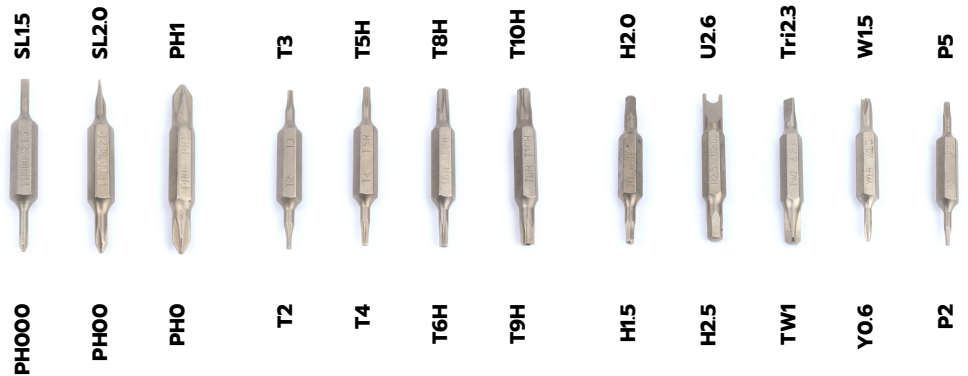

N. Ref.	Descrição	Marca	Quant. Caixa
61099	CHAVE C/BIT'S-MHT-24EM1	MADER HAND TOOLS	8/120

CHAVE DE VELAS
LLAVE DE BUJÍAS
SPARK PLUG WRENCH



16 / 21mm

Especificações / Especificaciones / Specifications **Articulada / Articulated**

N. Ref.	Descrição	Marca	Quant. Caixa
63675	CH VELAS-MPT-ARTICUL 16MM 21MM	MADER HAND TOOLS	50

ADAPTADOR » BITS
ADAPTADOR » PUNTAS
QUICK RELEASE BIT HOLDER



MAGNÉTICO



60mm



2un
60mm + 150mm



Descrição:	Adaptador p/ Bits	
Marca:	Mader Hand Tools	
N. Ref.	Especificação	Quant. Caixa:
59589	Magnético - 60mm	120/240
51198	2 un - 60+150 mm	10/100

ADAPTADOR P/ CHAVES DE CAIXA
ADAPATADOR P/ LLAVE DE VASO
SOCKET ADAPTERS



CHROME VANADIUM



6un



- 1/4" x 3/8"
- 3/8" x 1/2"
- 3/8" x 1/4"
- 1/2" x 3/8"
- 3/4" x 1/2"
- 1/2" x 3/4"

IMPACTO

OSCILANTE / AJUSTÁVEL



3un

- 1/4"
- 3/8"
- 1/2"

Descrição:	Kit Adaptadores	
Marca:	Mader Hand Tools	
N. Ref.	Especificação	Quant. Caixa:
59581	Redutor / Extensor - 6 un	24/24
61109	Impacto / Oscilante - 3 un	25/50

ROQUETE CARRACA RATCHET HANDLE



CHROME VANADIUM

72 Dentes

Descrição: Roquete

Marca: Mader Hand Tools

N. Ref.	Especificação	Quant. Caixa:
42657	1/4" - 72D	10/100
42656	1/2" - 72D	10/30
57631	1/4" - 72D - Profissional	25/100
57633	1/2" - 72D - Profissional	10/40



1/4"



1/2"



OSCILANTE / AJUSTÁVEL



1/4"



1/2"

PROFISSIONAL

CHAVE DINAMOMÉTRICA LLAVE TORSIÓN TORQUE WRENCH



1/4"
10un



1/2"
1un



1/2"
6un



REVERSÍVEL / REVERSIBLE

Roquete /Carraca /Ratchet:	1/4" - 270mm	1/2" - 460mm	1/2" - 470mm
Reversível /Reversible /Reversible			
Chaves Rodas /Llaves Ruedas /Wheel Socket:	x	x	17, 19, 21mm
Extensão /Prolongador /Extension:	x	x	1/2" - 125mm
Redutor /Reductor /Reducer:	x	x	1/2"x3/8"
Chaves Caixa /Llaves Vaso /Socket:	1/4" - H2.5, H3, H4, H5, H6, H8, H10, T25, T30	x	x
Torque Máx. /Torque Máx. /Max. Torque:	2.26 - 22.6Nm	28-210Nm	42-210Nm
Precisão /Precisión /Accurate: (Dentro-Within)	+/- 4%	+/- 4%	+/- 4%
Peso /Weight:	0.9Kg	1.36Kg	1.7Kg

Descrição: Chave Dinamométrica

Marca: Mader Hand Tools

N. Ref.	Especificação	Quant. Caixa:
61165	1/4" - 10 un	20
61167	1/2" - 1 un	10
61166	1/2" - 6 un	6



ROQUETE
CARRACA
RATCHET HANDLE



CHROME VANADIUM

72 Dentes



1/4"



1/2"



Descrição:	Roquete	
Marca:	Mader Hand Tools	
N. Ref.	Especificação	Quant. Caixa:
42650	1/4" - 72D	10
42651	1/2" - 72D	5/30

CHAVE DE CAIXA
LLAVES DE VASO
SOCKET TOOL SET

CHROME VANADIUM



51063

Chaves Caixa
/Llaves Vaso /Dr Spline:
19 un -1/2"
9, 10, 11, 12, 13, 14, 15, 16, 17, 18,
19, 20, 21, 22, 24, 27, 30, 32mm

Roquete
/Carraca /Ratchet Handle
1 un -1/2"



1/2"
19un

Descrição:	Chaves de Caixa	
Marca:	Mader Hand Tools	
N. Ref.	Especificação	Quant. Caixa:
51063	1/2" - 19 un	5/10

CHAVE DE CAIXA LLAVES DE VASO SOCKET TOOLS SET

CHROME VANADIUM

1/4"
12 un



Chaves Caixa | Llaves Vaso | Dr. Spline:
10 un - 1/4" - 4, 5, 6, 7, 8, 9, 10, 11, 12, 13 mm
Roquete | Carraca | Dr. Ratchet Handle:
1 un - 1/4" - 72 Dentes | Dientes | Teeth
Extensões | Alargaderas | Extension Bar:
1 un - 1/4" - 100 mm

1/2"
12 un



Chaves Caixa | Llaves Vaso | Dr. Spline:
10 un - 1/2" - 10, 11, 12, 13, 14, 15, 17, 19, 22, 24 mm
Roquete | Carraca | Dr. Ratchet Handle:
1 un - 1/2" - 72 Dentes | Dientes | Teeth
Extensões | Alargaderas | Extension Bar:
1 un - 1/2" - 125 mm

N. Ref.	Descrição	Marca	Quant. Caixa
61146	CH CX-MHT-1/4" 12UN CRV	MADER HAND TOOLS	5/20
61147	CH CX-MHT-1/2" 12UN CRV	MADER HAND TOOLS	5/10

CHAVE DE CAIXA LLAVES DE VASO SOCKET TOOLS SET

CHROME VANADIUM

1/4"
12 un



Chaves Caixa | Llaves Vaso | Dr. Spline:
10 un - 1/4" - 4, 5, 6, 7, 8, 9, 10, 11, 12, 13 mm
Roquete | Carraca | Dr. Ratchet Handle:
1 un - 1/4" - 72 Dentes | Dientes | Teeth
Extensões | Alargaderas | Extension Bar:
1 un - 1/4" - 150 mm

1/2"
20 un



Chaves Caixa | Llaves Vaso | Dr. Spline:
18 un - 1/2" - 9, 10, 11, 12, 13, 14, 15, 16, 17, 18, 19, 20, 21, 22, 24, 27, 30, 32 mm
Roquete | Carraca | Dr. Ratchet Handle:
1 un - 1/2" - 72 Dentes | Dientes | Teeth
Extensões | Alargaderas | Extension Bar:
1 un - 1/2" - 125 mm

N. Ref.	Descrição	Marca	Quant. Caixa
61177	CH CX-MHT-1/4" 12UN	MADER HAND TOOLS	50
61178	CH CX-MHT-1/2" 20UN	MADER HAND TOOLS	50

CHAVE DE CAIXA LLAVES DE VASO SOCKET TOOLS SET

CHROME VANADIUM



Chaves Caixa | Llaves Vaso | Dr. Spline:
13 un - 1/4" - 4, 4.5, 5, 5.5, 6, 7, 8, 9, 10, 11, 12, 13, 14 mm
Extensões | Alargaderas | Extension Bar:
2 un - 1/4" - 50, 100 mm
Extensões - Flexível | Alargaderas - Flexible
| Extension Bar - Flexible:
1 un - 1/4" - 150 mm
Cabo Corrediço | Mango Corredizo | Sliding T Bar:
1 un - 1/4"
Roquete | Carraca | Dr. Ratchet Handle:
1 un - 1/4" - 45 Dentes | Dientes | Teeth
Cardan Universal | Cardan Universal | Dr. Universal Joint:
1 un - 1/4"
Adaptador Bit | Adaptador Punta | Bit Adaptor:
1 un - 1/4"
Cabo Giratório | Mango Giratório | Spin Handle:
1 un - 1/4"
Chaves Caixa com Bit | Llaves Vaso con Punta
| Dr. Bit Socket: 21 un - 1/4"
- SL4, SL5.5, SL7, PH1, PH2, PH3, PZ1, PZ2, PZ3, H3, H4, H5,
H6, H7, H8, T10, T15, T20, T25, T30, T40
Chaves Sextavadas | Llaves Hexagonales | Hex Key:
3 un - 1.5, 2, 2.5 mm
Mala Transporte | Caja Transporte | Carrying Case:
1 un - Plástico | Plastic



1/4"
45 un

N. Ref.	Descrição	Marca	Quant. Caixa
61145	CH CX-MHT-1/4" 45UN CRV	MADER HAND TOOLS	20/20

CHAVE DE CAIXA LLAVES DE VASO SOCKET TOOLS SET

CHROME VANADIUM



Chaves Caixa | Llaves Vaso | Dr. Spline:
13 un - 1/4" - 4, 4.5, 5, 5.5, 6, 7, 8, 9, 10, 11, 12, 13, 14 mm
Extensões | Alargaderas | Extension Bar:
2 un - 1/4" - 50, 100 mm
Extensões - Flexível | Alargaderas - Flexible
| Extension Bar - Flexible: 1 un - 1/4" - 150 mm
Cabo Corrediço | Mango Corredizo | Sliding T Bar:
1 un - 1/4"
Roquete | Carraca | Dr. Ratchet Handle:
1 un - 1/4" - 45 Dentes | Dientes | Teeth
Cardan Universal | Cardan Universal | Dr. Universal Joint:
1 un - 1/4"
Adaptador Bit | Adaptador Punta | Bit Adaptor:
1 un - 1/4" - 30mm
Porta Bit | Porta Puntas | Bit Driver:
1 un - 1/4"
Chaves Caixa com Bit | Llaves Vaso con Punta
| Dr. Bit Socket: 21 un - 1/4"
- SL4, SL5.5, SL7, PH1, PH2, PH3, PZ1, PZ2, PZ3, H3, H4, H5,
H6, H7, H8, T10, T15, T20, T25, T30, T40
Chaves Sextavadas | Llaves Hexagonales | Hex Key:
4 un - 1.27, 2.5 mm
Mala Transporte | Caja Transporte | Carrying Case:
1 un - Plástico | Plastic



1/4"
46 un

N. Ref.	Descrição	Marca	Quant. Caixa
51049	CH CX-MHT-1/4" 46PCS CR-V	MADER HAND TOOLS	10

CHAVES DE CAIXA + BITS
LLAVES DE VASO + PUNTAS
SOCKET TOOL + BITS SET

CHROME VANADIUM



PROFISSIONAL



Roquete | Carraca | Dr. Ratchet Handle: 1un - 1/4" - 72 (Dentes / Dientes / Teeth)

Cabo Giratório | Mango Giratório | Spin Handle: 1un - 1/4"

Extensão | Prolongador | Dr. Extension Bar: 1un - 1/4" - 50mm

Cabo Corrediço | Mango Corredizo | Sliding T Bar: 1un - 1/4"

Chaves Caixa | Llaves Vaso | Sockets: 13un - 1/4" - 4, 4.5, 5, 5.5, 6, 7, 8, 9, 10, 11, 12, 13, 14mm

Chaves Sextavadas | Llaves Hexagonales | Hex Key Wrench: 8un - 1.5, 2, 2.5, 3, 4, 5, 5.5, 6mm

Bits | Puntas | Bits:

- ⊖ 4, 6mm (x50mm) ⊖ 3, 4, 4.5, 5, 5.5, 6, 6.5, 7, 8mm
 - ⊕ PH1, PH2 (x50mm) ⊕ PH0(x2), PH1(x2), PH2(x4), PH3(x2)
 - ⊗ PZ0(x2), PZ1(x2), PZ2(x4), PZ3(x2)
 - 1.5, 2, 2.5, 3, 4, 5, 5.5, 6, 8mm | 1/16", 5/64", 3/32", 7/64", 1/8", 5/32", 3/16", 9/64", 7/32", 1/4"
 - ⊙ 2, 2.5, 3, 4, 5, 6mm | 5/64", 3/32", 7/64", 1/8", 9/64", 5/32"
 - ⊛ T8, T10, T15, T20, T25, T27, T30, T35, T40, T45
 - ⊞ T8H, T10H, T15H, T20H, T25H, T27H, T30H, T35H, T40H
 - ⊗ M5, M6, M8 ⊙ S0, S1, S2, S3 ⌚ 1, 2, 3, 4 ⊕ 6, 8, 10 ↻ 4, 6, 8, 10 ⬇ C1, C2, C3
- 1un Bit em Y | Punta en Y | Y-Shaped Bit
 1un Adaptador Bits | Adapter Puntas | Bits Adapter - 1/4"

Descrição: Chaves de Caixa + Bits

Marca: Mader Hand Tools

N. Ref. Especificação

61176 1/4" - 131 un

Quant. Caixa:

4

CHAVE DE CAIXA LLAVES DE VASO SOCKET TOOL SET

CHROME VANADIUM **PROFISSIONAL**



Multi Lock
(todos os tipos de porcas)

1/2"
19un



Chaves Caixa /Llaves Vaso /Sockets:	
8, 9, 10, 11, 12, 13, 14, 15, 16, 17, 18, 19, 20, 21, 22, 24,	19 un- 1/2"
27, 30, 32mm	
Mala /Caja /Case: - Plástico	1 un

Descrição: Chaves de Caixa
Marca: Mader Hand Tools
N. Ref. Especificação
59579 1/2" - 19 un

Quant. Caixa:
10



CHAVE DE CAIXA LLAVES DE VASO SOCKET TOOL SET

CHROME VANADIUM



3/4"
20un + 1

3/4"
22un



Chaves Caixa /Llaves Vaso /Sockets:		
19, 21, 22, 23, 24, 26, 27, 29, 30, 32, 35, 36, 38, 41,	16 un-3/4"	16 un- 3/4"
46, 50mm		
Chave Corrediça /Llave Corrediza /Sliding Bar:		1 un - 3/4" - 450mm
Roquete /Carraca /Ratchet Handle	1 un -3/4" - 495mm	1 un - 3/4" - 500mm
Extensão /Alargadera /Extension Bar		
100, 200, 400mm	2 un - 3/4" (100-200)	3 un - 3/4"
Cabo /Mango /Sliding Bar	1 un - 450mm	
Mala /Caja /Case: - Plástico /Plastic	1 un	1 un

Descrição: Chaves de Caixa
Marca: Mader Hand Tools
N. Ref. Especificação
61159 3/4" - 20 un
51302 3/4" - 22 un

Quant. Caixa:
1
1



CHAVES CAIXA
LLAVES DE VASO
SOCKET TOOLS SET

Chrome-Vanadium



Chaves Caixa | Llaves Vaso | Dr. Spline: 10un - 1/4" - 4, 4.5, 5 5.5, 6, 7, 8, 9, 10, 11 mm;

9un - 3/8" - 11, 12, 13, 14, 15, 16, 17, 18, 19 mm

Cardan Universal | Dr. Universal Joint: 1un -3/8"

Chave Caixa Velas | Llave para Bujías | Spark Plug Socket:

1un - 3/8" x 16 mm

Extensões | Prolongadores | Dr. Extension Bar:

2un - 3/8" - 75, 150 mm

Roquete | Carraca | Dr. Ratchet Handle: 1un - 72 Dentes | Dientes | Teeth - 3/8" Cabo Giratório | Mango Giratório | Spin Handle: 1un - 1/4"

Bits | Pontas | Bits:

24un - SL3, SL4, SL5, SL6, SL7, PH0, PH1, PH2, PH3, PZ0, PZ1, PZ2, PZ3,

H2, H3, H4, H5, H6, T10, T15, T20, T25, T27, T30

Adaptador | Adaptor: 1un - 3/8"(F)-1/4"(M) Adaptador Bit | Adaptador Punta | Bit Adaptor: 1un - 1/4"

Iman Telescópico | Imán Telescópico | Pick Up Tools: 1un - 130-640 mm

Mala Transporte | Caja | Suitcase: 1un -Plástica | Plástico | Plastic



1/4" - 3/8"

52 un

N. Ref.	Descrição	Marca	Quant. Caixa
61175	CH CX-MHT-JG 1/4"-3/8" 52PCS	MADER HAND TOOLS	4

CHAVE DE CAIXA
LLAVES DE VASO
SOCKET TOOLS SET



- Chaves Caixa / Llaves Vaso / Dr. Spline**
- 19un - 1/2" - (Sextavada) - 8, 9, 10, 11, 12, 13, 14, 15, 16, 17, 18, 19, 20, 21, 22, 24, 27, 30, 32 mm
- 6un - 1/2" (Estriada) - 10, 12, 14, 15, 17, 19 mm
- Chaves Caixa Velas / Llaves para Bujías / Spark Plug Socket**
- 2un - 1/2" - 16, 21 mm
- Extensões / Alargaderas / Extension Bar**
- 2un - 1/2" - 125, 250 mm
- Roquete / Carraca / Dr. Ratchet Handle 1un - 1/2" - 45 Dentes**
- Cardan Universal / Dr. Universal Joint 1un - 1/2"**
- Adaptador 3 Vias / Adaptador 3 Vías / 3 Way Adaptor 1un**
- Mala Transporte / Caja / Carrynig Case**
- 1un - Plástica / Plástico / Plastic



1/2"
32un

N. Ref.	Descrição	Marca	Quant. Caixa
61144	CH CX-MHT-1/2" 32PCS CRV	MADER HAND TOOLS	6/12

CHAVE DE CAIXA LLAVES DE VASO SOCKET TOOL SET

CHROME VANADIUM



1/4" - 1/2"
108un

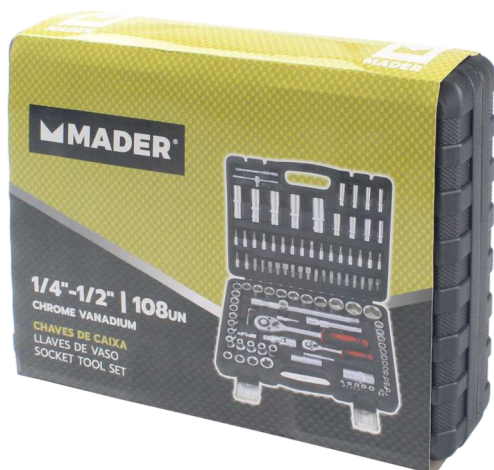

Chaves Caixa /Llaves Vaso /Sockets:	
4, 4.5, 5, 5.5, 6, 7, 8, 9, 10, 11, 12, 13, 14mm	13 un - 1/4"
10, 11, 12, 13, 14, 15, 16, 17, 18, 19, 20, 21, 22, 24, 27, 30, 32mm	17 un - 1/2"
Longa /Larga /Long	
6, 7, 8, 9, 10, 11, 12, 13mm	8 un - 1/4"
14, 15, 17, 19, 22mm	5 un - 1/2"
Torx: - E4, E5, E6, E7, E8	5 un - 1/4"
E10, E11, E12, E14, E16, E18, E20, E24	8 un - 1/2"
Vela /Bujías /Spark Plug - 16, 21mm	2 un - 1/2"
Chave Corrediça /Llave Corrediza /Sliding Bar:	1 un - 1/4"
	1 un - 3/8" x 1/2"
Roquete /Carraca /Ratchet Handle	1 un - 1/4" - 1/2"
Extensão /Alargadera /Extension Bar	
50, 100mm	2 un - 1/4"
125, 250mm	2 un - 1/2"
Cardan Universal /Juntas Universales /Universal Joint	2 un - 1/4" - 1/2"
Cabo Giratório /Mango Giratório /Spin Handle:	1 un - 1/4"
Bits /Puntas /Screwdriver Bit	
⊖ 8, 10, 12mm	3 un - 5/16"
⊕ PH3, PH4	2 un - 5/16"
⊗ PZ3, PZ4	2 un - 5/16"
● 7, 8, 10, 12, 14mm	5 un - 5/16"
⊛ T40, T45, T50, T55, T60	5 un - 5/16"
Chave Caixa /Llave Vaso /Socket	
⊖ 4, 5.5, 6.5mm	3 un - 1/4"
⊕ PH1, PH2	2 un - 1/4"
⊗ PZ1, PZ2	2 un - 1/4"
● 3, 4, 5, 6mm	4 un - 1/4"
⊛ T8, T10, T15, T20, T25, T27, T30	7 un - 1/4"
Adaptador /Adapter	1 un - 1/2" x 5/16"
Chaves /Llave /Wrench	
Hex: - 15, 2, 2.5mm	3 un
Mala /Caja /Case: - Plástico /Plastic	1 un

Descrição: Chaves de Caixa

Marca: Mader Hand Tools

N. Ref. Especificação

61154 1/4" - 1/2" - 108 un

Quant. Caixa:

3/3

CHAVES DE CAIXA LLAVES DE VASO SOCKET TOOLS SET

CHROME VANADIUM



Roquete com 72 Dentes
Carraca com 72 Dientes
Dr. Ratchet Handle with 72
Teeth



61143



5602225611433

218 un

1/4" - 3/8" - 1/2"

Chaves Caixa | Llaves Vaso | Dr. Spline:
13 un - 1/4" - 4, 4.5, 5, 5.5, 6, 7, 8, 9, 10, 11, 12, 13, 14 mm
10 un - 3/8" - 10, 11, 12, 13, 14, 15, 16, 17, 18, 19 mm
14 un - 1/2" - 13, 14, 15, 16, 17, 18, 19, 20, 21, 22, 24, 27, 30, 32 mm
Chaves Caixa Longa | Llaves Vaso Largas | Dr. Deep Spline:
7 un - 1/4" - 4, 5, 6, 7, 8, 9, 10 mm
6 un - 3/8" - 10, 11, 12, 13, 14, 15 mm
5 un - 1/2" - 16, 17, 18, 19, 22 mm
Chaves Caixa Torx | Llaves Vaso Torx | Torx Dr. Spline :
5 un - 1/4" - E4, E5, E6, E7, E8
6 un - 3/8" - E10, E11, E12, E14, E16, E18
3 un - 1/2" - E20, E22, E24
Chaves Caixa Velas | Llaves Vaso Bujias | Spark Plug Socket:
1 un - 3/8" - 21 mm
2 un - 1/2" - 16, 21 mm
Chaves Caixa com Bit | Llaves Vaso con Punta | Dr. Bit Socket: 30 un - 1/4"
Fenda | Plana | Flat: SL4, SL5, SL5.5, SL6, SL7
Philips | Philips | Philips: PH1, PH2, PH3
Pozidrive | Pozidrive | Pozidrive: PZ1, PZ2, PZ3
Sextavada | Hexagonal | Hex:
H2, H3, H4, H5, H6, H7, H8, H10
Torx / Furo | Torx / Hoyo | Torx / Hole:
TX8, TX10, TX15, TX20, TX25, TX27, TX30, TX40
Dodecagonal | Dodecagonal | Dodecagonal: M4, M5, M6
Chaves Caixa com Bit | Llaves Vaso con Punta | Dr. Bit Socket: 2 un - 1/2"
Torx | Torx | Torx: T55, T60
Roquete | Carraca | Dr. Ratchet Handle:
3 un - 1/4" - 3/8" - 1/2" (72 D|T)
Extensões | Alargaderas | Extension Bar:
2 un - 1/4" - 50, 100 mm
1 un - 3/8" - 150 mm
2 un - 1/2" - 125, 250 mm
Cabo T Corrediço | Mango T Corredizo | Sliding T Bar:
1 un - 1/4"
Cabo Giratório | Mango Giratório | Spin Handle: 1 un - 1/4"
Cardan Universal | Cardan Universal | Dr. Universal Joint:
3 un - 1/4" - 3/8" - 1/2"
Adaptador | Adaptador | Adaptor:
1 un - 3/8"(F) - 1/2" (M)
Adaptador Bit | Adaptador Punta | Bit Adaptor:
3 un - 1/4" - 3/8" - 1/2"
Bits | Puntas | Bits: 30 un - 8 mm
Fenda | Plana | Flat: SL3, SL4, SL5, SL6, SL7
Philips | Philips | Philips: PH0, PH1, PH2, PH3
Pozidrive | Pozidrive | Pozidrive: PZ0, PZ1, PZ2, PZ3
Sextavada | Hexagonal | Hex: H5, H6, H8, H10
Torx | Torx | Torx: T25, T27, T30, T35, T40, T45, T50, T55
Torx / Furo | Torx / Hoyo | Torx / Hole:
TX27, TX30, TX35, TX40, TX45, TX50, TX55
Dodecagonal | Dodecagonal | Dodecagonal:
M5, M6, M8, M10
Bits | Puntas | Bits: 50 un - 6,35 mm
Fenda | Plana | Flat: SL3, SL4, SL5, SL6, SL7
Philips | Philips | Philips: PH0, PH1, PH2, PH3
Pozidrive | Pozidrive | Pozidrive: PZ0, PZ1, PZ2, PZ3
Sextavada | Hexagonal | Hex:
H1.5, H2, H2.5, H3, H4, H5, H5.5, H6
Torx | Torx | Torx:
T8, T9, T10, T15, T20, T25, T27, T30, T40
Torx / Furo | Torx / Hoyo | Torx / Hole:
TX8, TX10, TX15, TX20, TX25, TX27, TX30, TX40
Dodecagonal | Dodecagonal | Dodecagonal: M5, M6
Quadrado | Cuadrado | Square: SQ0, SQ1, SQ2, SQ3
Spanner | Spanner | Spanner: SP4, SP6, SP8
3 Wings | 3 Wings | 3 Wings: TW1, TW2, TW3
Porta Bit | Porta Puntas | Bit Driver: 1 un - 1/4"
Chaves Sextavadas | Llaves Hexagonales | Hex Key Wrench:
4 un - 1.27, 1.5, 2, 2.5 mm
Chaves Boca-Luneta | Llave Combinada
| Combination Spanner:
12 un - 8, 9, 10, 11, 12, 13, 14, 15, 16, 17, 18, 19 mm

N. Ref.	Descrição	Marca	Quant. Caixa
61143	CH CX-MHT-1/4"-3/8"-1/2" 218UN	MADER HAND TOOLS	2/2

KIT FERRAMENTA JUEGO HERRAMIENTA TOOL SET



- 1un - Martelo carpinteiro: 8OZ
- 1un - Porta bits
- 1un - Alicata universal: 6"
- 2un - Chaves de precisão
- 20un - Bits CRV: 25mm
- 1un - Martillo orejas: 8OZ
- 1un - Porta puntas
- 1un - Alicata universal: 6"
- 2un - Llaves de precisión
- 20un - Puntas CRV: 25mm
- 1un - Claw hammer: 8OZ
- 1un - Bits holder
- 1un - Combination plier: 6"
- 2un - Precision screwdrivers
- 20un - CRV Bits: 25mm



52151



5602225521510

25Un

N. Ref.	Descrição	Marca	Quant. Caixa
52151	KIT FERRAMENTAS-MHT-25UN	MADER HAND TOOLS	10

KIT FERRAMENTA JUEGO HERRAMIENTA TOOL SET



- 1un - Martelo carpinteiro: 8OZ
- 1un - Chave crescente: 6"
- 1un - Porta bits
- 1un - Alicata universal : 6"
- 1un - Proteção de borracha para martelo
- 12un - Bits CRV: 25mm
- 1un - Martillo orejas: 8OZ
- 1un - Llave ajustable: 6"
- 1un - Porta puntas
- 1un - Alicata universal: 6"
- 1un - Protector de goma para el martillo
- 12un - Puntas CRV: 25mm
- 1un - Claw hammer: 8OZ
- 1un - Adjustable wrench: 6"
- 1un - Bits holder
- 1un - Combination plier: 6"
- 1un - Ruber cover for hammer
- 12un - CRV Bits: 25mm



52150



5602225521503

17Un

N. Ref.	Descrição	Marca	Quant. Caixa
52150	KIT FERRAMENTAS-MHT-17UN	MADER HAND TOOLS	10

MALA DE FERRAMENTA CAJA DE HERRAMIENTA HAND TOOL SET



51306



516022251513065

78un
3/8"

» » » CHROME VANADIUM « « «



Ferramenta /Herramienta /Tool

Chaves Caixa /Llaves Vaso /Sockets:

8, 9, 10, 11, 12, 13, 14, 15, 16, 17, 18, 19, 21, 22mm 14 un - 3/8"

Roquete /Carraca /Ratchet Handle 1 un - 3/8"

Extensão /Alargadera /Extension Bar
75 mm 1 un - 3/8"

Bits /Puntas / Screwdriver Bit

⊖ 3, 4, 5, 5.5, 6 mm 5 un

⊕ PH0, PH1, PH2(x2), PH3 5 un

⊗ Hex: 2, 3, 4, 5, 6 mm 5 un

⦿ S0, S1, S2(X2), S3 5 un

⦿ T10, T15, T20, T25, T30 5 un

⦿ PZ0, PZ1, PZ2(x2), PZ3 5 un

Cabo /Mango /Handle 1 un - 1/4"

Chaves /Destornillador /Screwdrivers

⊖ 6x100, 6x150 mm 2 un

⊕ PH2x100mm; PH2x150mm 2 un

Precisão /Precisión /Precision

⊕ PH00-S15, PH0-S25 2 un

⦿ T4-H2, T7-H15 2 un

Cabo /Mango /Handle 1 un

Chaves /Llave /Wrench

Boca-Luneta /Fijas Combinadas /Combination:
8, 10, 11, 12, 13, 14, 15, 17 mm 8 un

Sextavadas /Hex:
15, 2, 25, 3, 4, 5, 6, 8, 10 mm 9 un

Alicate /Plier

Universal /Combination 1 un - 7"

Pontas /Boca Redonda /Long Nose : 1 un - 6"

Corte Lateral /Corte Diagonal /Diagonal : 1 un - 6"

Fita Métrica /Flexómetro /Measuring Tape: 1 un - 3 m

Martelo Carpinteiro /Martillo Orejas /Claw Hammer 1 un - 300 gr

Mala /Caja /Case: - Plástico /Plastic 1 un

Descrição: Mala de Ferramenta

Marca: Mader Hand Tools

N. Ref. Especificação

51306 Sortida - 78 un

Quant. Caixa:

3/3

MALA DE FERRAMENTA
CAJA DE HERRAMIENTA
HAND TOOL SET

CHROME VANADIUM

Mala Metálica
Malletin Metallica
Matalic Case

5 Divisórias
5 Particiones
5 Partitions



SERROTE + MARTELO BOLA
SIERRA + MARTILLO BOLA
HACKSAW + BALL HAMMER



- Chaves Caixa | Llaves Vaso | Dr. Spline:
11 un - 1/4"
14 un - 1/2"
- Roquete | Carraca | Dr. Ratchet Handle:
2 un - 1/4" - 1/2" (72 D/T)
- Extensões | Alargaderas | Extension Bar:
1 un - 1/4" - 75 mm
2 un - 1/2" - 125, 250 mm (3 Vias | Way)
- União | Unión | Dr. Socket Plug:
2 un - 1/2" - 16, 21 mm
- Bits | Puntas | Bits: 11 un - 1/4" - 25 mm
Fenda | Plana | Flat: SL4, SL5.5, SL7
Philips | Philips | Philips: PH1, PH2, PH3
Sextavada | Hexagonal | Hex: H3, H4, H5, H6, H8
- Adaptador Bit | Adaptador Punta | Bit Adaptor: 1 un - 1/4"
- Junta Universal | Junta Universal | Universal Joint: 1 un - 1/2"
- Chave para Bit | Llave para Punta | Bit Driver: 1 un
- Chave Parafusos | Destornillador | Screwdriver: 15 un
Fenda | Plana | Flat: SL5x75, SL6x100, SL8x150 mm
Philips | Philips | Philips: PH1x75, PH2x100 mm
- Chaves Sextavadas | Llaves Hexagonales | Hex Key
Wrench: 10 un - H1.5, H2, H2.5, H3, H4, H5, H6, H7, H8, H10
- Chaves Boca-Luneta | LLave Combinada | Combination
Spanner: 12 un - 6, 7, 8, 9, 10, 11, 12, 13, 14, 15, 16, 17 mm
- Alicate | Alicates | Plier: 4 un
Pontas Redondas | Boca Redonda | Long Nose: 150 mm
Corte Lateral | Corte Diagonal | Diagonal Cut: 150 mm
Bomba d' Água | Pico Loro | Groove Joint: 250 mm
Fixação | Mordaza | Locking: 250 mm
- X-Ato | Cortador | Knife: 1 un - 18 mm
- Lâminas | Cuchillas | Blades: 10 un - 18 mm
- Serrote | Sierra | Hacksaw: 1 un - 300 mm
- Martelo Carpinteiro | Martillo Orejas | Claw Hammer:
1 un - 16 oz
- Fita métrica | Flexómetro | Tape measure: 1 un - 3 m



61158



5602225611587

93 un
1/4" - 1/2"

N. Ref.	Descrição	Marca	Quant. Caixa
61158	MALA FERRAMENTAS-MHT-93PÇS MET	MADER HAND TOOLS	1

MALA COM FERRAMENTAS
CAJA CON HERRAMIENTA
HAND TOOL SET

CHROME VANADIUM

Roquete com 72 Dentes
 Carraca con 72 Dientes
 Dr. Ratchet Handle with 72
 Teeth



4 Divisórias
 4 Particiones
 4 Partitions



Chaves Caixa|Llaves Vaso|Dr. Spline:
 13 un - 1/4"
 4, 4.5, 5, 5.5, 6, 7, 8, 9, 10, 11, 12, 13, 14 mm
 13 un - 1/2"
 10, 13, 14, 16, 17, 18, 19, 20, 22, 24, 27, 30, 32 mm
 Chaves Caixa Velas|Llaves Vaso Bujias|Spark Plug Socket:
 2 un - 1/2" - 16, 21 mm
 Roquete|Carraca|Dr. Ratchet Handle:
 2 un - 1/4" - 1/2" (72 D|T)
 Extensões|Alargaderas|Extension Bar:
 2 un - 1/4" - 2", 4"
 1 un - 1/2" - 5"
 Cabo T Corrediço|Mango T Corredizo|Sliding T Bar:
 2 un - 1/4" - 1/2"
 Cardan Universal|Cardan Universal|Dr. Universal Joint:
 2 un - 1/4" - 1/2"
 Bits|Puntas|Bits: 31 un
 Chave para Bit c/ Roquete|Llave para Punta c/ Carraca
 |Bit Driver w/ Ratchet: 1 un
 Chave Parafusos|Destornillador|Screwdriver: 4 un
 Fenda|Plana|Flat: SL5x75, SL6x100 mm
 Philips|Philips|Philips: PH1x75, PH2x100 mm
 Chave Parafusos Precisão|Destornillador Precisión
 |Precision Screwdriver: 7 un - 6 IN 1
 Chave Busca-Pólos|Buscapolos|Voltage Tester: 1 un - 140 mm
 Chaves Sextavadas|Llaves Hexagonales
 |Hex Key Wrench: 9 un - 1.5 » 10 mm
 Chaves Boca-Luneta|Llave Combinada|Combination Spanner: 9
 un - 8, 10, 11, 12, 13, 15, 17, 19, 22 mm
 Chave Crescente|Llave Ajustable|Adjustable Wrench: 1 un - 10"
 Alicates|Alicates|Plier: 9 un
 Universal|Universal|Combination: 7"
 Pontas Redondas|Boca Redonda|Long Nose: 8"
 Corte Lateral|Corte Diagonal|Diagonal Cut: 6"
 Bomba d' Água|Pico Loro|Groove Joint: 10"
 Freios|Arandelas|Circlip: 4 IN 1
 Descarnar|Ojetero|Stripping: 9"
 X-Ato|Cortador|Knife: 1 un
 Serrote|Sierra|Hacksaw: 1 un - 6"
 Lâminas|Cuchillas|Blades: 3 un
 Martelo Carpinteiro|Martillo Orejas|Claw Hammer: 1 un - 12 oz
 Fita métrica|Flexómetro|Tape measure: 1 un - 5 m
 Nível|Nivel|Level: 1 un - 12" Alimium
 Terminais|Treminales|Terminals: 6 un



59603



560222596037

123 un

Mala de transporte: 1un - Plastic.
Maletín de transporte: 1un - Plastic.
Transport case: 1un - Plastic.

N. Ref.	Descrição	Marca	Quant. Caixa
59603	MALA FERRAM-MHT-122PC CX ALUM	MADER HAND TOOLS	2

MALA FERRAMENTAS
CAJA HERRAMIENTAS
HAND TOOL SET

4 Divisórias
4 Particiones
4 Partitions



Estrutura Reforçada
Estructura Reforzada
Reinforced Structure



TROLLEY



142 un
1/4" - 1/2"

CHROME VANADIUM

Professional
Professional
Professional

Roquete » 72 Dentes
Carraca » 72 Dientes
Dr. Ratchet Handle » 72 Teeth



Chaves Caixa | Llaves Vaso | Dr. Spline:
12 un - 1/4"
4, 4.5, 5, 5.5, 6, 7, 8, 9, 10, 11, 12, 13 mm
11 un - 1/2"
10, 12, 13, 14, 15, 17, 18, 19, 20, 22, 24 mm
Chaves Caixa Velas | Llaves Vaso Bujias | Spark Plug
Socket: 2 un - 1/2" - 16, 21 mm
Roquete | Carraca | Dr. Ratchet Handle: 2 un - 1/4" - 1/2"
Extensões | Alargaderas | Extension Bar:
2 un - 1/4" - 50, 100 mm
2 un - 1/2" - 125, 250 mm
Cabo T Corrediço | Mango T Corredizo | Sliding T Bar:
2 un - 1/4" - 1/2"
Cardan Universal | Cardan Universal | Dr. Universal Joint:
2 un - 1/4" - 1/2"
Bits | Puntas | Bits:
30 un - 25 mm
10 un - 50 mm
Adaptador Bit | Adaptador Punta | Bit Adaptor:
1 un - 1/4" - 25mm
Extensão Bit | Alargaderas Punta | Bit Extension:
1 un - 60 mm - Magnetic
Porta Bit | Porta Puntas | Bit Driver: 1 un - 1/4" - Magnetic
Chave Parafusos | Destornillador | Screwdriver: 6 un
Fenda | Plana | Flat: SL5.5x75, SL6x100, SL6x38 mm
Philips | Philips | Philips: PH1x75, PH2x100, PH2x38 mm
Chave Parafusos Precisão | Destornillador Precisión
| Precision Screwdriver: 5 un
Chave Parafusos VDE | Destornillador VDE
| VDE Screwdriver: 2 un
Fenda | Plana | Flat: SL4x100 mm
Philips | Philips | Philips: PH2x100 mm
Chave Busca-Pólos | Buscapolos | Voltage Tester:
1 un - 140 mm
Chaves Sextavadas | Llaves Hexagonales
| Hex Key Wrench: 9 un - 1.5 - 10 mm
Chaves Boca-Luneta | LLave Combinada
| Combination Spanner: 7 un - 8, 10, 11, 12, 13, 14, 17 mm
Chave Crescente | Llave Ajustable | Adjustable Wrench:
1 un - 200 mm
Alicate | Alicates | Plier: 3 un
Universal | Universal | Combination: 1 un - 180 mm
Corte Lateral | Corte Diagonal | Diagonal Cut:
1 un - 160 mm
Bomba d'Água | Pico Loro | Groove Joint: 1 un - 220mm
Lima | Lima | File:
Meia-Cana | Media Caña | Half Round: 1 un - 200 mm
X-Ato | Cortador | Knife: 1 un - 18 mm
Lâminas | Cuchillas | Blades: 10 un - 18 mm
Serrote | Sierra | Hacksaw: 1 un - 300 mm
Lâminas | Cuchillas | Blades: 3 un - 300 mm
Martelo Pena | Martillo Pluma | Joints Hammer: 1 un
Régua | Regla | Ruler: 1 un - 150 mm
Esquadro | Escuadra | Square: 1 un - 250 mm
Fita métrica | Flexómetro | Tape measure: 1 un - 5 m
Paquímetro | Calibre | Caliper: 1 un - 150 mm
Nível | Nivel | Level: 1 un - 400 mm
Lápis Carpinteiro | Lápiz Carpenter | Caliper: 6 un
Ímã | Imán | Magnetic Pickup Tool: 1 un
Lanterna | Linterna | Flashlight: 1 un - 50 Lm

N. Ref.	Descrição	Marca	Quant. Caixa
61157	MALA FERRAMENTAS-MHT-142PC	MADER HAND TOOLS	1

CARRO FERRAMENTA CARRO DE HERRAMIENTA TOOL CART



Dimensões /Dimensiones /Size: - 793x785x480mm
6 un. - Gaveta /Cajón /Drawer
1 un. - Porta /Porta /Door
156 un. - Ferramenta /Herramienta /Tool



Descrição: **Carro Ferramenta**
 Marca: **Mader Hand Tools**
 N. Ref. Especificação
 51312 156 un - 7 Divisórias

Quant. Caixa:
1

METAL



PROFISSIONAL



156un
1/4" - 3/8" - 1/2"



Gavetas
c/ deslizamento fácil
e fecho de segurança

TRAVÃO
FRENO
BRAKE



7 Divisórias
Particiones
Partitions

Cajones
c/ rodamientos fácil
deslizamiento
y cerradura de seguridad

» » » CHROME VANADIUM « « «

Chaves Caixa /Llaves Vaso /Sockets:	
4, 4.5, 5, 5.5, 6, 7, 8, 9, 10, 11, 12, 13, 14mm	13 un - 1/4"
8, 9, 10, 11, 12, 13, 14, 15, 16, 17, 18, 19, 20, 21, 22, 24mm	16 un - 3/8"
10, 11, 12, 13, 14, 15, 16, 17, 18, 19, 21, 22, 23, 24, 27, 30, 32mm	17 un - 1/2"
Longa /Larga /Long	
4, 5, 6, 7, 8, 9, 10, 11, 12mm	9 un - 1/4"
Chave Corrediça /Llave Corrediza /Sliding Bar:	
3 un - 1/4" - 3/8" - 1/2"	
Roquete /Carraca /Ratchet Handle	
3 un - 1/4" - 3/8" - 1/2"	
Extensão /Alargadera /Extension Bar	
50, 100mm	2 un - 1/4"
75, 150mm	2 un - 3/8"
125, 250mm	2 un - 1/2"
Cardan Universal /Juntas Universales /Universal Joint	
3 un - 1/4" - 3/8" - 1/2"	
Cabo /Mango /Handle:	
1 un - 1/4"	
Bits /Puntas /Screwdriver Bit	
Chave Caixa /Llave Vaso /Socket	
⊖ SL3, SL4, SL5, SL6 ⊕ PH1, PH2, PH3, ⊗ PZ1, PZ2, PZ3 ⊙ H3, H6, H7, H8 ⊕ T8, T10, T15, T20, T25, T30, T40	21 un - 1/4"
Chaves Parafusos /Destornillador /Screwdrivers	
⊖ 6x38, 3x75, 4x100, 5x100, 6x150, 8x200mm	6 un
⊕ PH2x38, PH0x75, PH1x100, PH2x100, PH2x150, PH3x1200	6 un
VDE ⊖ 3x75, 4x100, 5x125	3 un
VDE ⊕ PH0x75, PH1x100, PH2x100	3 un
Precisão /Precisión /Precision	
1, 2, 3	3 un
PH0, PH1, PH2	3 un
Chaves /Llave /Wrench	
Torx T9, T10, T15, T20, T25, T27, T30, T40	8 un
Hex 15, 2, 2.5, 3, 4, 5, 6, 8, 10mm	9 un
Boca-Luneta, Combinadas, Combination	
fixas /fijas /fixed	
8, 9, 10, 11, 12, 13, 14, 15, 16, 17, 19, 20, 22mm	13 un
Alicate /Plier	
Universal /Combination	1 un - 8"
Pontas /Boca Redonda /Long Nose :	1 un - 8"
Corte Lateral /Corte Diagonal /Diagonal :	1 un - 7"
Bomba d'Água /Pico Loro /Water Pump:	1 un - 10"
Fixação /Mordaza /Locking	1 un - 10"
Freios /Arandelas /Circlip	4 un - 6"
Mala /Caja /Case: - Plástico /Plastic	1 un

CARRO FERRAMENTA CARRO DE HERRAMIENTA TOOL CART



Dimensões /Dimensiones /Size: - 793x785x480mm
6 un. - Gaveta /Cajón /Drawer
1 un. - Porta /Porta /Door
156 un. - Ferramenta /Herramienta /Tool



**Chave Combinada
c/ Roquete-Carraca»»**



METAL



PROFISSIONAL



156un
1/4" - 3/8" - 1/2"



Gavetas
c/ deslizamento fácil
e fecho de segurança

TRAVÃO
FRENO
BRAKE



7 Divisórias
Particiones
Partitions

Cajones
c/ rodamentos fácil
deslizamiento
y cerradura de seguridad

» » » CHROME VANADIUM « « «

Chaves Caixa /Llaves Vaso /Sockets:	
4, 4.5, 5, 5.5, 6, 7, 8, 9, 10, 11, 12, 13, 14mm	13 un - 1/4"
8, 9, 10, 11, 12, 13, 14, 15, 16, 17, 18, 19, 20, 21, 22, 24mm	16 un - 3/8"
10, 11, 12, 13, 14, 15, 16, 17, 18, 19, 21, 22, 23, 24, 27, 30, 32mm	17 un - 1/2"
Longa /Larga /Long	
4, 5, 6, 7, 8, 9, 10, 11, 12mm	9 un - 1/4"
Chave Corrediça /Llave Corrediza /Sliding Bar:	3 un - 1/4" - 3/8" - 1/2"
Roquete /Carraca /Ratchet Handle	3 un - 1/4" - 3/8" - 1/2"
Extensão /Alargadera /Extension Bar	
50, 100mm	2 un - 1/4"
75, 150mm	2 un - 3/8"
125, 250mm	2 un - 1/2"
Cardan Universal /Juntas Universales /Universal Joint	3 un - 1/4" - 3/8" - 1/2"
Cabo /Mango /Handle:	1 un - 1/4"
Bits /Puntas /Screwdriver Bit	
Chave Caixa /Llave Vaso /Socket	
⊖ SL3, SL4, SL5, SL6 ⊕ PH1, PH2, PH3, ⊗ PZ1, PZ2, PZ3	21 un - 1/4"
⊙ H3, H6, H7, H8 ⊕ T8, T10, T15, T20, T25, T30, T40	
Chaves Parafusos /Destornillador /Screwdrivers	
⊖ 6x38, 3x75, 4x100, 5x100, 6x150, 8x200mm	6 un
⊕ PH2x38, PH0x75, PH1x100, PH2x100, PH2x150, PH3x1200	6 un
VDE ⊖ 3x75, 4x100, 5x125	3 un
VDE ⊕ PH0x75, PH1x100, PH2x100	3 un
Precisão /Precisión /Precision	
1, 2, 3	3 un
PH0, PH1, PH2	3 un
Chaves /Llave /Wrench	
Torx T9, T10, T15, T20, T25, T27, T30, T40	8 un
Hex 15, 2, 2.5, 3, 4, 5, 6, 8, 10mm	9 un
Boca-Luneta, Fijas Combinadas, Combination c/ Roquete /con Carraca /Ratchet	
8, 9, 10, 11, 12, 13, 14, 15, 16, 17, 19, 20, 22mm	13 un
Alicate /Plier	
Universal /Combination	1 un - 8"
Pontas /Boca Redonda /Long Nose :	1 un - 8"
Corte Lateral /Corte Diagonal /Diagonal :	1 un - 7"
Bomba d'Água /Pico Loro /Water Pump:	1 un - 10"
Fixação /Mordaza /Locking	1 un - 10"
Freios /Arandelas /Circlip	4 un - 6"
Mala /Caja /Case: - Plástico /Plastic	1 un

Descrição: **Carro Ferramenta**
 Marca: **Mader Hand Tools**
 N. Ref. Especificação
 51311 156 un - 7 Divisórias

Quant. Caixa:
1

TABULEIRO » CARRO FERRAMENTA
BANDEJA » CARRO DE HERRAMIENTA
TRAY » TOOL CART

»»»» **CHROME VANADIUM** ««««
PROFISSIONAL

CHAVES BOCA-LUNETETA
 LLAVES COMBINADAS
 COMBINATION WRENCH

ROQUETE
 CARRACA
 RATCHET

13 un
 8, 9, 10, 11, 12, 13, 14,
 15, 16, 17, 19, 21, 22mm



Nº 1
 13un

CHAVES
 LLAVES
 WRENCH

9 un - 1/4" » Caixa Longa /Vaso Larga /Long Socket
 4, 5, 6, 7, 8, 9, 10, 11, 12mm
23 un - 1/4" » Caixa /Vaso /Socket + Bit
 SL3-SL4-SL5-SL6 || PH1-PH2-PH3-PZ1-PZ2-PZ3-H3
 H4-H5-H6-H7-H8 || T8-T10-T15-T20-T25-T30-T40
9 un - Sextavada /Hexagonale /Hex Key
 15, 2, 2.5, 3, 4, 5, 6, 8, 10mm



Nº 2
 41un

ALICATE
 PLIER

1 un - 10" » Fixação /Mordaza /Locking
1 un - 10" » Bomba d'Água /Pico Loro /Water Pump



Nº 3
 2un

ALICATE
 PLIER

1 un - 8" » Universal /Combination
1 un - 8" » Pontas /Boca Redonda /Long Nose
1 un - 7" » Corte Lateral /Corte Diagonal /Diagonal



Nº 4
 3un

2 un - 6" » Ponta Direita /Boca Semi-Redonda /Long Nose
 Interior /Internal || Exterior /External
2 un - 6" » Ponta Curva /Boca Curvada /Bent Nose
 Interior /Internal || Exterior /External

ALICATE FREIOS
 ALICATE ARANDELAS
 SNAP RING PLIE



Nº 5
 4un

Descrição: **Tabuleiro » Carro Ferramenta**

Marca: **Mader Hand Tools**

N. Ref.	Especificação	Quant. Caixa:
51315	Nº 1 - 13 un	1/8
51316	Nº 2 - 41 un	1
51317	Nº 3 - 2 un	1/10
51318	Nº 4 - 3 un	1/10
51319	Nº 5 - 4 un	1/12

TABULEIRO » CARRO FERRAMENTA
BANDEJA » CARRO DE HERRAMIENTA
TRAY » TOOL CART

»»»» CHROME VANADIUM ««««
PROFISSIONAL

CHAVES PARAFUSO
DESTORNILLADORES
SCREWDRIVER

6 un
 PH0x75, PH1x100, PH2x38, PH2X100, PH2x150, Ph3x200



Nº 6
 6un

CHAVES PARAFUSO
DESTORNILLADORES
SCREWDRIVER

6 un
 6x38, 3x75, 4x100, 5X100, 6x150, 8x200 mm



Nº 7
 6un

CHAVES PARAFUSO
DESTORNILLADORES
SCREWDRIVER

6 un - VDE
 PH0x75, PH1x100, PH2X100 || 3x75, 4x100, 5X100mm
6 un - Precisão /Precisión /Precision
 PH0, PH1, PH2 || 1, 2, 3mm
8 un - Torx
 T9, T10, T15, T20, T25, T27, T30, T40



Nº 8
 20un

CHAVES CAIXA
LLAVES VASO
SOCKETS

17 un - 1/2" » 10, 11, 12, 13, 14, 15, 16, 17, 18, 19, 20, 21, 22, 23, 24, 27, 30, 32mm
1 un - 1/4" » Chave Corrediça /Llave Corrediza /Sliding Bar T
1 un - 1/2" » Roquete /Carraca /Ractchet Handle
2 un - 1/2" » Extensão /Alargadera /Extension Bar 125, 250mm
1 un - 1/2" » Cardan Universal /Juntas Universales /Universal Joint



Nº 9
 22un

CHAVES CAIXA
LLAVES VASO
SOCKETS

13 un - 1/4" » 4, 4.5, 5, 5.5, 6, 7, 8, 9, 10, 11, 12, 13, 14mm
1 un - 1/4" » Chave Corrediça /Llave Corrediza /Sliding Bar T
1 un - 1/4" » Roquete /Carraca /Ractchet Handle
2 un - 1/4" » Extensão /Alargadera /Extension Bar 50, 100mm
1 un - 1/4" » Cardan Universal /Juntas Universales /Universal Joint
1 un - 1/4" » Cabo /Mango /Handle



Nº 10
 19un

Descrição: **Tabuleiro » Carro Ferramenta**

Marca: **Mader Hand Tools**

N. Ref.	Especificação	Quant. Caixa:
51320	Nº 6 - 6 un	1/10
51321	Nº 7 - 6 un	1/12
51322	Nº 8 - 20 un	1/12
51323	Nº 9 - 22 un	1
51324	Nº 10 - 19 un	1/10

PONTA MAGNÉTICA / PUNTA MÁGNÉTICA

VENTOSA VENTOSA SUCTION PAD

Estrutura em plástico resistente com ventosas;
De fácil utilização
Apertar os clips de ambas as pegas para fazer sucção;
Ideal para tratar amolgadelas ou elevar artigos lisos;

Estructura en plástico resistente con ventosas;
De fácil uso
Apretar las grapas de ambas las manijas p/ hacer succión;
Ideal para tratar abolladuras o izar artículos llanos;

Durable plastic body with rubber suction cup;
Easy to use
Tighten and clip the two handles to create suction;
Great for pulling dents or lifting flat items;



50Kg
ref:125 - 120mm



DUPLA
DOBLE
DOUBLE

70Kg
ref:125 - 120mm



TRIPLA
TRIPLE

100Kg
ref:125 - 125mm

Descrição: **Ventosa**

Marca: **Mader Hand Tools**

N. Ref.	Especificação	Quant. Caixa:
61011	Simples - 50 Kg - 120mm	100/100
61012	Dupla - 70 Kg - 120mm	50/50
61013	Dupla - 100 Kg - 125mm	30/30

BANDEJA DE BORRACHA BANDEJA DE GOMA RUBBER TOOL TRAY

100% FLEXÍVEL
FLEXIBLE

ADERENTE
ADHERENTE
NON-SLIP

270x134x25mm



Descrição: **Bandeja Borracha**

Marca: **Mader Hand Tools**

N. Ref.	Especificação	Quant. Caixa:
61218	27 x 13,4 cm	20/20
61219	27 x 21,6 cm	20/20



270x216x25mm

O'RINGS JUNTAS DE GOMA O-RINGS

- | | | |
|--------------------------|--------------------------|--------------------------|
| 20un -3x1.5mm; | 23un -7x1.5mm; | 23un -10x1.5mm |
| 23un -13x1.5mm; | 20un -4.4x2.0mm; | 18un -5x2.0mm; |
| 14un -10x2.5mm; | 13un -11x2.5mm; | 14un -13x2.5mm; |
| 13un -14x2.5mm; | 14un -16x2.5mm; | 14un -18x2.5mm; |
| 13un -19x2.5mm; | 14un -21x2.5mm; | 13un -22x2.5mm; |
| 10un -18x3.5mm; | 10un -20x3.5mm; | 10un -22x3.5mm; |
| 10un -23.5x3.5mm; | 10un -25x3.5mm; | 10un -26.5x3.5mm; |
| 10un -28x3.5mm; | 10un -30x3.5mm; | 10un -31x3.5mm; |
| 10un -33x3.5mm; | 10un -34.5x3.5mm; | 10un -36x3.5mm; |
| 10un -38x3.5mm; | 10un -41x3.5mm; | 10un -44x3.5mm; |
| 10un -47x3.5mm; | 10un -50x3.5mm; | |



419un



Descrição: O' rings

Marca: Mader Hand Tools

N. Ref. Especificação
61550 419 Un

Quant. Caixa:
20

MULTÍMETRO MULTIMETRO DIGITAL MULTIMETER



- Tensão DC /Tensión DC /DC Voltage
- Tensão AC /Tensión AC /AC Voltage
- Corrente DC /Corriente DC /DC Current
- Teste de Transistores /Transistor Test
- Medidor de Resistencia /Ohm
- Teste de Diodos /Teste de Diodos /Diode Test

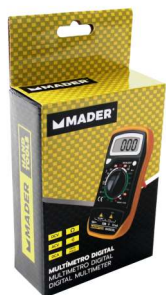

- Tensão DC /Tensión DC /DC Voltage
- Tensão AC /Tensión AC /AC Voltage
- Corrente DC /Corriente DC /DC Current
- Teste de Transistores /Transistor Test
- Medidor de Resistencia /Ohm
- Teste de Diodos /Teste de Diodos /Diode Test

Descrição: Multímetro

Marca: Mader Hand Tools

N. Ref. Especificação
61006 830B - Digital
61007 830L - Digital

Quant. Caixa:
10/40
1/40

TORNO BANCADA
TORNILLO DE BANCO
BENCH VICE



FIXO
FIJO
FIXED

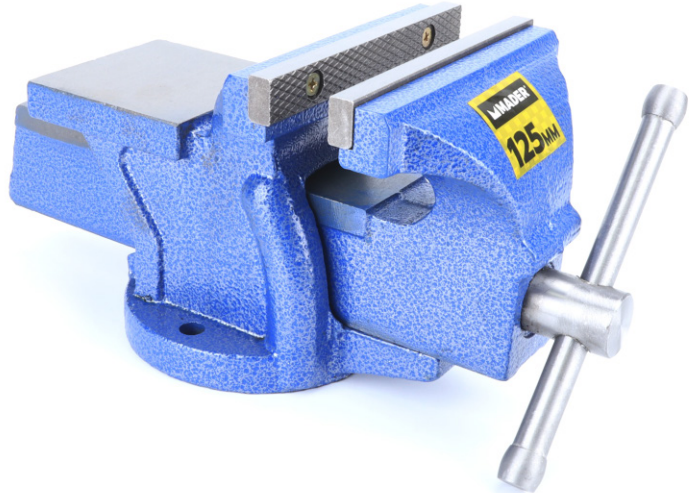

100 mm - 4"

125 mm - 5"



N. Ref.	Descrição	Marca	Quant. Caixa
23155	TORNO BANCADA-MHT-B.FIXA 100MM	MADER HAND TOOLS	1/4
23156	TORNO BANCADA-MHT-B.FIXA 125MM	MADER HAND TOOLS	1/2

Aço
Acero
Steel

TORNO BANCADA
TORNILLO DE BANCO
BENCH VICE



FIXO
FIJO
FIXED

2 Ton

2.4 Ton

100 mm - 4"

125 mm - 5"



3 Ton

3.4 Ton

150 mm - 6"

200 mm - 8"

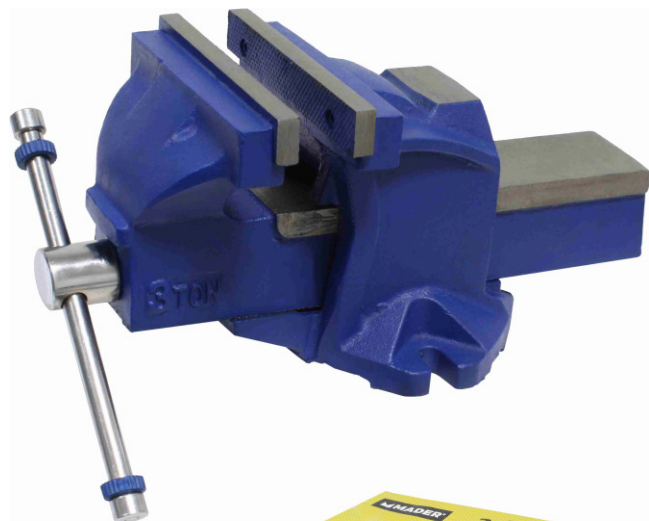

N. Ref.	Descrição	Marca	Quant. Caixa
23148	TORNO BANCADA-MHT-FIXO 100MM	MADER HAND TOOLS	2
23157	TORNO BANCADA-MHT-FIXO 125MM	MADER HAND TOOLS	2
23149	TORNO BANCADA-MHT-FIXO 150MM	MADER HAND TOOLS	1
23158	TORNO BANCADA-MHT-FIXO 200MM	MADER HAND TOOLS	2

Aço
Acero
Steel

TORNO DE BANCADA
TORNILLO DE BANCO
BENCH VICE



BATENTE e BASE ROTATIVA
TOPE y BASE GIRATORIA
ANVIL and SWIVEL BASE

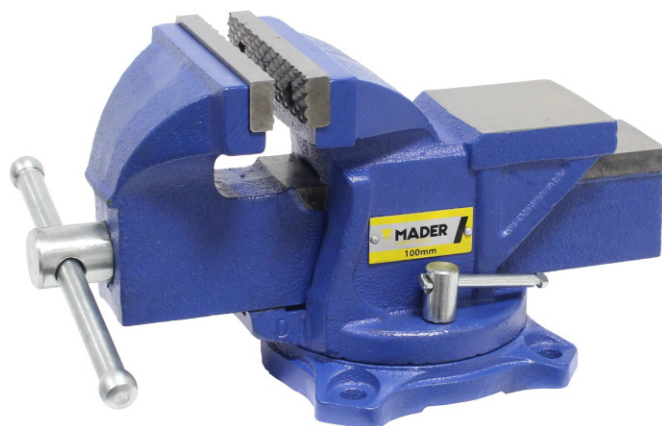

125 mm - 5"

150 mm - 6"



N. Ref.	Descrição	Marca	Quant. Caixa
23152	TORNO BANCADA-MHT-B.GIR-125MM	MADER HAND TOOLS	2/2
23153	TORNO BANCADA-MHT-B.GIR-150MM	MADER HAND TOOLS	2/2

Aço
Acero
Steel

TORNO DE BANCADA
TORNILLO DE BANCO
BENCH VICE



TORNO MULTIFUNÇÕES
TORNILLO MULTIFUNCIÓN
MULTI-PURPOSE VICE

Base Rotativa 360°
Base Giratoria 360°
Swivel Base 360°



125 mm - 5"



Aço
Acero
Steel

- Base Giratória 360 c/ Porcas de Bloqueio Duplo
- Grampa de tubo serrilhado
- Punho em T deslizante cromado
- Profundidade: 70mm
- Bigorna: 80x64mm

- Base giratória de 360° com tuercas de bloqueio dobles
- Mordazas dentadas para tubos
- Mango em T deslizante cromado
- Profundidad: 70mm
- Yunque: 80x64mm

N. Ref.	Descrição	Marca	Quant. Caixa
23154	TORNO MULTIFUN-MHT-B.GIR 125MM	MADER HAND TOOLS	1

MARTELO DE BOLA MARTILLO DE BOLA BALL PEIN HAMMER

CABO FIBRA VIDRO / TPR
MANGO FIBRA DE VIDRIO
FIBERGLASS HANDLE



16oz 29mm
454gr

CABO DE MADEIRA
MANGO EN MADERA
WOODEN HANDLE



24oz 32mm
680gr



32oz 35mm
907gr



16oz 27mm
454gr



REFORÇADO / REFORZADO / REINFORCED

Descrição:	Martelo de Bola	
Marca:	Mader Hand Tools	
N. Ref.	Especificação	Quant. Caixa:
61026	C. Madeira - 16 oz	6/36
61027	C. Madeira - 24 oz	6/24
61028	C. Madeira - 32 oz	6/24
61025	C. Fibra TPR - 16 oz	6/36
61428	C. Fibra TPR - 24 oz - Reforç	6/24
61429	C. Fibra TPR - 48 oz - Reforç	6/12



24oz 35mm
680gr



48oz 42mm
1360gr

MAÇO DE BORRACHA MAZA GOMA RUBBER Mallet

PRETO
NEGRO
BLACK

CABO DE MADEIRA
MANGO EN MADERA
WOODEN HANDLE

BRANCO
BLANCO
WHITE

CABO DE MADEIRA
MANGO EN MADERA
WOODEN HANDLE



12oz 50mm
340gr



8oz 48mm
227gr



12oz 50mm
340gr

CABO FIBRA VIDRO / TPR
MANGO FIBRA DE VIDRIO
FIBERGLASS HANDLE



16oz 55mm
454gr



BRANCO
BLANCO
WHITE

Descrição:	Maço de Borracha	
Marca:	Mader Hand Tools	
N. Ref.	Especificação	Quant. Caixa:
61058	Preto - 8 oz - C. Madeira	6/36
61059	Preto - 12 oz - C. Madeira	6/36
61060	Branco - 12 oz - C. Madeira	6/36
61043	Branco - 16 oz - C. F. TPR Ref.	6/24

MARTELO DE CARPINTEIRO
MARTILLO DE OREJAS
CLAW HAMMER

TIPO AMERICANO



20oz
567gr
29mm

CABO FIBRA VIDRO
MANGO FIBRA DE VIDRIO
FIBERGLASS HANDLE

CABO DE MADEIRA
MANGO EN MADEIRA
WOODEN HANDLE



16oz
495gr
25mm

CURTO /CORTO /SHORT

CABO FIBRA VIDRO /TPR
MANGO FIBRA DE VIDRIO
FIBERGLASS HANDLE



8oz
227gr
25mm

CABO FIBRA VIDRO /TPR
MANGO FIBRA DE VIDRIO
FIBERGLASS HANDLE



20oz
567gr
29mm

Descrição: **Martelo de Carpinteiro**

Marca: **Mader Hand Tools**

N. Ref.	Especificação	Quant.	Caixa:
61023	C. Madeira - 16 oz - 25 mm	6/36	
61024	C. Madeira - 22 oz - 27 mm	6/6	
61055	C. Fibra - 20 oz	6/24	
61056	C. Fibra TPR - 8 oz - Curto	1/80	
61021	C. Fibra TPR - 20 oz	6/24	

MARTELO MARTILLO HAMMER

300gr 22mm **385gr** 25 mm

MARTELO DE PENNA
MARTILLO DE PEÑA
JOINER'S HAMMER

CABO DE MADEIRA
MANGO EN MADERA
WOODEN HANDLE



480gr
28mm

MARTELO COFRAGEM
MARTILLO ENCOFRADOR
ROOFING HAMMER

CABO FIBRA VIDRO
MANGO FIBRA DE VIDRIO
FIBERGLASS HANDLE **/TPR**



Descrição: **Martelo**

Marca: **Mader Hand Tools**

N. Ref.	Especificação	Quant. Caixa:
61029	Pena - 11 oz - C. Mad.	6/48
61030	Pena - 14 oz - C. Mad.	6/48
61031	Pena - 17 oz - C. Mad.	6/36
50714	Cofragem - 21 oz - C. Fibra TPR	6/24



2oz
600gr
29 mm

MACHADO HACHA AXE

600g

800g

1Kg

MACHADINHA
HACHA
HATCHET

CABO FIBRA VIDRO
MANGO FIBRA DE VIDRIO
FIBERGLASS HANDLE **/TPR**



1,5Kg

2Kg



CABO FIBRA VIDRO
MANGO FIBRA DE VIDRIO
FIBERGLASS HANDLE
REFORÇADO /REFORZADO /REINFORCED

Descrição: **Machado**

Marca: **Mader Hand Tools**

N. Ref.	Especificação	Quant. Caixa:
90654	600 gr - C. Fibra TPR	6/24
90655	800 gr - C. Fibra TPR	6/12
90656	1 Kg - C. Fibra TPR	12
61420	1,5 Kg - C. F. TPR Ref.	6/6
61421	2 Kg - C. F. TPR Ref.	6/6

MACHADINHA

HACHA
AXE



Cabo Fibra Vidro

Mango Fibra de Vidro
Fiberglass Handle



450 g
200 mm

N. Ref.	Descrição	Marca	Quant. Caixa
61418	MACHADINHA-MHT-450G	MADER HAND TOOLS	6/24

MACHADINHA

HACHA
AXE



MULTIUSOS MULTIFUNCTION

Monopieza - Cabo em Aço

Monopieza - Cable Acero
Monopiece - Steel Cable



300 g
120 mm

N. Ref.	Descrição	Marca	Quant. Caixa
61419	MACHADINHA-MHT-MULTIUSOS	MADER HAND TOOLS	6/50

com Chave Luneta: 19 - 15 - 10 mm
con Llave Acodada: 19 - 15 - 10 mm
with Ring Spanner: 19 - 15 - 10 mm

MARTELO MARTILLO HAMMER



CABO FIBRA VIDRO
MANGO FIBRA DE VIDRO / **TPR**
FIBERGLASS HANDLE



500gr

25mm

Cabo - 480mm

MARTELO FAZ TUDO
ALCOTANA PALA MARTILLO
MASON'S HAMMER



600gr

29mm

Cabo - 330mm

MARTELO PEDREIRO
ALCOTANA PALA MARTILLO
MASON'S HAMMER



500gr

Cabo - 330mm

PICADEIRA
ALCOTANA PICO PALA
MASON'S HAMMER

Descrição: **Martelo**

Marca: **Mader Hand Tools**

N. Ref. Especificação Quant. Caixa:

61033 Faz Tudo - 18 oz - C. Fibra TPR 24/24

61034 Pedreiro - 21 oz - C. Fibra TPR 24/24

61032 Picadeira - 500 gr - C. Fibra TPR 24

ARRANCA PREGOS DESENCOFRADOR NAIL PULLER



Descrição: **Arranca Pregos**

Marca: **Mader Hand Tools**

N. Ref. Especificação Quant. Caixa:

61041 30" x 3/4" (19mm) 12/12

61042 36" x 3/4" (19mm) 10/10



30" x 3/4"
19mm



36" x 3/4"
19mm

MARRETA
MACETA
STONING HAMMER

QUADRADA
CUADRADA
SQUARE



CABO DE MADEIRA
MANGO EN MADERA
WOODEN HANDLE



CABO FIBRA VIDRO
MANGO FIBRA DE VIDRIO
FIBERGLASS HANDLE

/TPR



1Kg



1,5Kg



1Kg



1Kg



1,5Kg



2Kg



CABO FIBRA VIDRO
MANGO FIBRA DE VIDRIO
FIBERGLASS HANDLE

/TPR

TIPO ESPANHA

Descrição: **Marreta**

Marca: **Mader Hand Tools**

N. Ref.	Especificação	Quant. Caixa:
61046	Quad. - 1 Kg - C. Madeira	6/24
61047	Quad. - 1,5 Kg - C. Madeira	6/12
61057	Quad. - 1 Kg - C. Fibra TPR	6/24
61048	Quad. - 1 Kg - C. Fibra TPR	6/24
61049	Quad. - 1,5 Kg - C. Fibra TPR	6/12
61050	Quad. - 2 Kg - C. Fibra TPR.	6/12
61044	T. Espanha - 1 Kg - C. Fibra TPR	6/24



1Kg



CABO FIBRA VIDRO
MANGO FIBRA DE VIDRIO
FIBERGLASS HANDLE

/TPR

MARRETA
MACETA
STONING HAMMER

QUADRADA
CUADRADA
SQUARE

CABO FIBRA VIDRO
MANGO FIBRA DE VIDRIO
FIBERGLASS HANDLE **/TPR**



3Kg



4Kg



5Kg



6Kg

Descrição: **Marreta**

Marca: **Mader Hand Tools**

N. Ref.	Especificação	Quant. Caixa:
61051	Quadrada - 3 Kg - C. Fibra TPR	4
61052	Quadrada - 4 Kg - C. Fibra TPR	4
61053	Quadrada - 5 Kg - C. Fibra TPR	4
61054	Quadrada - 6 Kg - C. Fibra TPR	2/2

PICARETA MARTILLO PIQUETA RAILROAD PICK

CABO FIBRA VIDRO
MANGO FIBRA DE VIDRIO / **TPR**
FIBERGLASS HANDLE



2,5Kg



3Kg



3Kg

REFORÇADO
REFORZADO
REINFORCED

Descrição:	Picareta	
Marca:	Mader Hand Tools	
N. Ref.	Especificação	Quant. Caixa:
61035	2,5 Kg - C. Fibra TPR	6
61036	3 Kg - C. Fibra TPR	6/6
61433	3 Kg - C. Fibra TPR Reforçado	6

MACETA DE CANTEIRO MACETA CANTERO ROUND HAMMER

CABO FIBRA VIDRO
MANGO FIBRA DE VIDRIO / **TPR**
FIBERGLASS HANDLE



1Kg

Descrição:	Maceta Canteiro	
Marca:	Mader Hand Tools	
N. Ref.	Especificação	Quant. Caixa:
61065	1 Kg - C. Fibra TPR	6/12

ESCOPRO ESCOPRO FLAT CHISEL

COM PROTECÇÃO
CON PROTECCIÓN
WITH PROTECTION



Descrição: Escopro com Protecção

Marca: Mader Hand Tools

N. Ref. Especificação Quant. Caixa:

50760 16 x 300 mm 6/36

50761 16 x 400 mm 6/24



16 x 300mm



16 x 400mm

PONTEIRO PUNTERO CHISEL

COM PROTECÇÃO
CON PROTECCIÓN
WITH PROTECTION



Descrição: Ponteiro com Protecção

Marca: Mader Hand Tools

N. Ref. Especificação Quant. Caixa:

50762 16 x 300 mm 6/36

50763 16 x 400 mm 6/24



16 x 300mm



16 x 400mm

ESCOPRO E PONTEIRO ESCOPLO Y PUNTERO FLAT CHISEL AND CHISEL

Ponteiro /Puntero /Chisel - 6, 8mm (87428-87429)
Punção /Punzone /Punch - 2mm (87428-87429)
Escopro /Escoplo /Flat Chisel - 10, 12, 16mm (87428-87429)
Punção /Punzone /Punch - 15, 3, 4, 5, 6, 8mm (87429)

Descrição: Escopro e Ponteiro

Marca: Mader Hand Tools

N. Ref. Especificação Quant. Caixa:

87428 6 un 4

87429 12 un 4/16



6un



12un

VAZADOR DE PANCADA PERFORADOR MANUAL HOLLOW PUNCH

3, 4, 5, 6, 8, 10mm



Descrição: Vazador de Pancada

Marca: Mader Hand Tools

N. Ref. Especificação Quant. Caixa:

51674 6 un

10/100

6un



CABO FIBRA VIDRO MANGO FIBRA DE VIDRIO FIBERGLASS HANDLE

CABO FIBRA VIDRO / TPR MANGO FIBRA DE VIDRIO / TPR FIBERGLASS HANDLE

para /to:
Martelo de Carpinteiro
Martillo de Orejas
Claw Hammer



16oz



20oz

para /to:
Martelo de Bola
Martillo de Bola
Ball Pein Hammer



16oz

para /to:
Marreta Quadrada
Maceta Cuadrada
Square Stoning Hammer



1Kg



1,5Kg



2Kg

para /to:
Marreta Quadrada
Maceta Cuadrada
Square Stoning Hammer



3Kg



4Kg



5Kg



6Kg



Descrição: Cabo Fibra Vidro / TPR

Marca: Mader Hand Tools

N. Ref. Especificação

Quant. Caixa:

61468	p/ Martelo - 16 oz	80
61469	p/ Martelo - 20 oz	80
61470	p/ Martelo Bola - 16 oz	80
61471	p/ Marreta - 1 Kg	80
61472	p/ Marreta - 1,5 Kg	80
61473	p/ Marreta - 2 Kg	80
61462	p/ Marreta - 3 Kg - Longo	20
61463	p/ Marreta - 4 Kg - Longo	20
61464	p/ Marreta - 5 Kg - Longo	20
61465	p/ Marreta - 6 Kg - Longo	6/20
61466	p/ Picareta - 2,5 Kg - Longo	6/16
61467	p/ Picareta - 3 Kg - Longo	16/16

para /to:
Picareta
Martillo Piqueta
Railroad Pick



2,5Kg



3Kg



X-ATO / FACA ALCATIFA

CORTADOR
UTILITY KNIFE

Plástico
Plastico
Plastic

1 Lâmina
1 Cuchilla
1 Blade



9 mm
0.39 x 9 x 80 mm

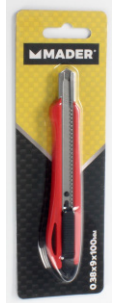

18 mm
0.5 x 18 x 110 mm



N. Ref.	Descrição	Marca	Quant. Caixa
61241	FACA ALCAT-MHT-0,38X9X80MM 1LM	MADER HAND TOOLS	24/288
61242	FACA ALCAT-MHT-0,5X18X100MM 1L	MADER HAND TOOLS	24/144

X-ATO / FACA ALCATIFA

CORTADOR
UTILITY KNIFE

Plástico
Plastico
Plastic

1 + 2 Lâmina
1 + 2 Cuchilla
1 + 2 Blade



9 mm
0.39 x 9 x 80 mm

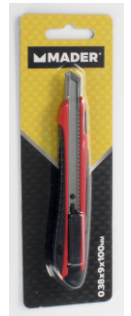

18 mm
0.5 x 18 x 110 mm



N. Ref.	Descrição	Marca	Quant. Caixa
61243	FACA ALCAT-MHT-0,38X9X80MM 3LM	MADER HAND TOOLS	24/288
61244	FACA ALCAT-MHT-0,5X18X100MM 3L	MADER HAND TOOLS	24/144

Reservatório para 2 Lâminas
Depósito para 2 Cuchillas
Reservoir for 2 Blades



X-ATO / FACA ALCATIFA

CORTADOR
UTILITY KNIFE

Alumínio
Aluminio
Aluminum

1 Lâmina
1 Cuchilla
1 Blade

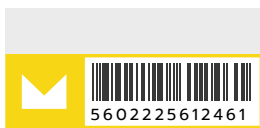

18 mm
0.5 x 18 x 110 mm



N. Ref.	Descrição	Marca	Quant. Caixa
61246	FACA ALCATIFA-MHT-18MM ALUM	MADER HAND TOOLS	12/48

X-ATO / FACA ALCATIFA CORTADOR UTILITY KNIFE

ABS + TPR

1 Lâmina
1 Cuchilla
1 Blade



61239



5602225612393

18 mm
0.5 x 18 x 110 mm



61238



5602225612386

25 mm
0.7 x 25 x 126 mm



Com íman
Con imán
With magnet

N. Ref.	Descrição	Marca	Quant. Caixa
61239	FACA ALCATIFA-MHT-18MM ABS+TPR	MADER HAND TOOLS	12/144
61238	FACA ALCAT-MHT-0,7X25X126MM 1L	MADER HAND TOOLS	12/120

LÂMINA PARA X-ATO CUCHILLA DE CORTADOR BLADES FOR UTILITY KNIFE

10 un



9 mm

18 mm

25 mm

0.38 x 9 x 80 mm

0.5 x 18 x 110mm

0.7 x 25 x 126mm



5602225612478



5602225612485



5602225612492

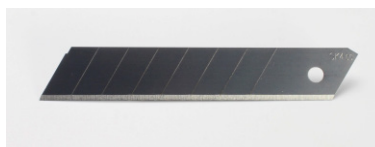

N. Ref.	Descrição	Marca	Quant. Caixa
61247	LÂMINA FACA ALCAT-MHT-9MM 10P	MADER HAND TOOLS	20/24
61248	LÂMINA FACA ALCAT-MHT-18MM 10P	MADER HAND TOOLS	24/240
61249	LÂMINA FACA ALCATIFA-25MM 10P	MADER HAND TOOLS	12/120

X-ATOS + LÂMINAS CORTADORES + CUCHILLAS UTILITY KNIFES + BLADES

10 un



61237



5602225612379

X-Atos | Cortadores | Utility Knives:
2 un - 9mm, 18mm
Lâminas | Cuchillas | Blades:
3 un - 9mm
5 un - 18mm

N. Ref.	Descrição	Marca	Quant. Caixa
61237	FACA ALCATIFA-MHT-KIT 10UN	MADER HAND TOOLS	6/36

FACA ALCATIFA CORTADOR UTILITY KNIFE



61240



5602225612409

18 mm
24 un

1 Lâmina
1 Cuchillas
1 Blade

Sortido
Surtido
Miscellaneous

Lâmina / Cuchilla / Blade **18 x 110 x 0.5 mm**

N. Ref.	Descrição	Marca	Quant. Caixa
61240	FACA ALCATIFA-MHT-18MM EXP 24P	MADER HAND TOOLS	6

AFIADOR DE FACAS AFILADORES CUCHILOS KNIFE SHARPNER



5602225614113



5602225614120

com Ventosa
con Ventosa
with Suction Pad

N. Ref.	Descrição	Marca	Quant. Caixa
61411	AFIADOR-MHT-P/FACAS ND-022	MADER HAND TOOLS	100
61412	AFIADOR-MHT-P/FACAS ND-019	MADER HAND TOOLS	90

CORTADOR DE VIDRO CORTADOR DE VIDRIO GLASS CUTTER



98893



5602225988931

5"
125 x 6,5 mm

N. Ref.	Descrição	Marca	Quant. Caixa
98893	CORTA VIDRO-MHT-5"	MADER HAND TOOLS	12

RASPADOR METÁLICO RASCADOR METÁLICO METALLIC SCRAPER

CABO LONGO
CABLE LARGO
LONG HANDLE



102 x 320 mm



Cabo / Cable

320 mm



10 un
102 x 14 mm

LÂMINAS PARA RASPADOR
LAMINA PARA RASCADOR
BLADE FOR SCRAPER



N. Ref.	Descrição	Marca	Quant. Caixa
20097	RASPADOR C/MET-MEX-18"	MADER	6/72
20098	LÂMINA P/RASPADOR-MHT-4"	MADER HAND TOOLS	12/144

SERROTE MULTIUSOS SERRUCHO MULTIUSOS WALLBOARD SAW

Lâmina em aço endurecido
Dentes extra afiados
Ideal para perfurar Pladur

Cuchilla de acero endurecido
Dientes extra afilados
Ideal para perfurar Pladur

Hardened steel blade
Extra sharp teeth
Ideal for drilling Plasterboard

tipo Faca
tipo Cuchillo
Knife type



150 mm

N. Ref.	Descrição	Marca	Quant. Caixa
61015	SERROTE -MHT-MULTI 150MM	MADER HAND TOOLS	12/72

SERROTE FOLHA LARGA SERRUCHO CARPINTERO CARPENTER SAW

Madeira, Contraplacado, Aglomerado
Madera, Contrachapado, Conglomerado
Wood, Plywood, Chipboard

Dentes tipo "CROSS JAPONÊS"
Dientes tipo "CROSS JAPONÊS"
Teeth like "JAPANESE CROSS"



450 mm

500 mm



N. Ref.	Descrição	Marca	Quant. Caixa
61398	SERROTE F/LARGA-MHT-450MM	MADER HAND TOOLS	60
61399	SERROTE F/LARGA-MHT-500MM	MADER HAND TOOLS	1/60



Cabo Bi-Matéria
Mango Bi-Materia
Bi-Material Cable

SERROTE COSTAS SERRUCHO COSTILLA TENON SAW

Dentes tipo "CROSS JAPONÊS"
Dientes tipo "CROSS JAPONÊS"
Teeth like "JAPANESE CROSS"

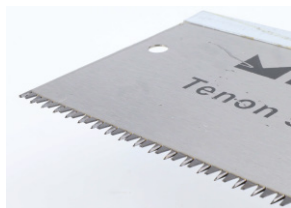

Madeira, Aglomerado
Madera, Conglomerado
Wood, Chipboard

300 mm

350 mm



Cabo Bi-Matéria
Mango Bi-Materia
Bi-Material Cable

N. Ref.	Descrição	Marca	Quant. Caixa
61404	SERROTE COSTAS-MHT-300MM	MADER HAND TOOLS	1
61406	SERROTE COSTAS-MHT-350MM	MADER HAND TOOLS	1

SERROTE COSTAS SERRUCHO COSTILLA TENON SAW

Esquadria
Caja Ingletes
Mitre Box

300 x 140 x 55 mm



com Esquadria
con Caja Ingletes
with Mitre Box



300 mm

N. Ref.	Descrição	Marca	Quant. Caixa
61403	SERROTE COSTAS-MHT-C/ESQUAD	MADER HAND TOOLS	1/12

Cabo Bi-Material
Mango Bi-Material
Bi-Material Handle

CAIXA ESQUADRIA CAJA INGLETES MITRE BLOCK



135 x 40 x 20 mm



N. Ref.	Descrição	Marca	Quant. Caixa
61409	CX ESQUADRIA-MHT-METALICA	MADER HAND TOOLS	300

METAL / ALUMINIO

SERROTE CORTE FERRO SERRUCHO CORTE METAL METAL CUT HACKSAW

CORTE METAL
METAL CUT



Cabo Ferro
Cable Hierro
Metal Handle

300 mm



Cabo Alumínio
Cable Aluminio
Aluminium Handle

300 mm



com Esticador
con Tensor
Hacksaw Frame

N. Ref.	Descrição	Marca	Quant. Caixa
30007	SERROTE C/FERRO-MHT-C/MET 2089	MADER HAND TOOLS	48
61402	SERROT C/FERRO-MHT-C/ALU 300MM	MADER HAND TOOLS	12/48

KIT SERROTES JUEGO SERRUCHOS SAW KIT

Corte Ferro
Corte Metal
Metal Cut



2 Posições de Corte
2 Posiciones de Corte
2 Cutting Positions



4 un
2 un - 150, 300 mm

Serrote com Esticador, Cabo Alumínio
| Serrucho con Tensor, Mango Alumínio
| Hacksaw Frame, Aluminium Handle:
1 un - 300mm
Mini Serrote | Mini Serrucho | Mini Hacksaw:
1 un - 150mm
Punho para Lâmina | Mango para Cuchilla | Handle for
Blade:
1 un
Caixa Esquadria Metálica | Caja Ingletes Metálica | Metal
Mitre Block:
1 un

N. Ref.	Descrição	Marca	Quant. Caixa
61401	KIT SERROTES-MHT-4UN C/FERRO - 300MM	MADER HAND TOOLS	10/20

LÂMINA CORTE FERRO LAMINA CORTE HIERRO IRON CUT BLADE

Aço Carbono
Acero Carbono
Carbon Steel



1 un
12"

HSS



1 un
12"

Bi-Metal



1 un
12"



made in DINAMARCA



**10 un x 10 (caixa com 100un)
compra mínima de 10 un**
10 un x 10 (caja con 100 un)
compra mínima de 10 unidades
10 un x 10 (box with 100 un)
minimum purchase of 10 units



N. Ref.	Descrição	Marca	Quant. Caixa
56037	LÂMINA C/FERRO-MPT-A/CARBONO	MADER HAND TOOLS	100
56038	LÂMINA C/FERRO-MAD-HSS	MADER HAND TOOLS	100
56039	LÂMINA C/FERRO-MPT-BI METAL	MADER HAND TOOLS	100

LÂMINA DE CORTE DE FERRO LAMINA DE CORTE DE HIERRO IRON CUT BLADE



3 un
12"



Bi-Metal



1 un
12"

**10 un x 10 (caixa com 100un)
compra mínima de 10 un**
10 un x 10 (caja con 100 un)
compra mínima de 10 unidades
10 un x 10 (box with 100 un)
minimum purchase of 10 units



N. Ref.	Descrição	Marca	Quant. Caixa
61405	LAMINA BI-METAL-MHT 12" 3UN CF	MADER HAND TOOLS	10/250
61407	LAMINA BI-MET-MHT-12" 24T 1UN	MADER HAND TOOLS	10/100

LIMAS LIMAS FILE SET

PARALELA FLAT



6" 150mm



8" 200mm



10" 250mm



4" 100mm



6" 150mm



TRIÂNGULAR TRIANGULAR TRIANGLE



MEIA-CANA MEDIA-CAÑA HALF ROUND

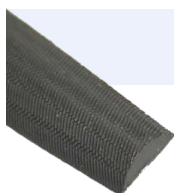

6" 150mm



8" 200mm



10" 250mm



6" 150mm



8" 200mm

REDONDA ROUND



10" 250mm



Descrição: Lima

Marca: Mader Hand Tools

N. Ref.	Especificação	Quant. Caixa:
51600	Paralela - 6"	10/100
51601	Paralela - 8"	10/100
51602	Paralela - 10"	10/60
51603	Triangular - 4"	10/100
51604	Triangular - 6"	10/100
51607	Meia-Cana - 6"	10/100
51608	Meia-Cana - 8"	10/100
51609	Meia-Cana - 10"	6/60
51610	Redonda - 6"	10/100
51611	Redonda - 8"	10/100
51612	Redonda - 10"	10/60

GROSA ESCOFINA WOOD RASP

PARALELA
FLAT



8" 200mm



10" 250mm



MEIA-CANA
MEDIA-CAÑA
HALF ROUND



8" 200mm



10" 250mm

Descrição: **Grosa**

Marca: **Mader Hand Tools**

N. Ref.	Especificação	Quant. Caixa:
51620	Paralela - 8"	10/100
51621	Paralela - 10"	6/60
51622	Meia-Cana - 8"	10/100
51623	Meia-Cana - 10"	10/60
51624	Redonda - 8"	10/50
51625	Redonda - 10"	6/60



8" 200mm



10" 250mm

REDONDA
ROUND



LIMAS LIMAS FILE SET



6" 150mm



8" 200mm

QUADRADA
CUADRADA
SQUARE



PARALELA
FLAT

P/ AFIAR CORRENTE
AFLADORA CADENA
CORRUGATING FILE



6" 150mm

Descrição: **Lima**

Marca: **Mader Hand Tools**

N. Ref.	Especificação	Quant. Caixa:
51605	Quadrada - 6"	10/100
51606	Quadrada - 8"	10/100
51613	Afia Corrente - 6" - Retângular	10/100
51614	Afia Corrente - 8"	10/100
52320	Afia Corrente, 3/16" - Redonda	20/100



3/16" P/ MOTOSERRA

3/16" **REDONDA**
200mm **ROUND**



1/8"
200mm



LIMAS PRECISÃO LIMAS PRECISIÓN PRECISION FILE SET

GR150

DIAMANTE

Paralela | Paralela | Flat: 1 un
Meia-Cana | Media Caña | Half Round: 1 un
Triângular | Triángular | Triangle: 1 un
Quadrada | Cuadrada | Square: 1 un
Redonda | Redonda | Round: 1 un



5 un
140 mm

N. Ref.	Descrição	Marca	Quant. Caixa
51634	LIMA PRECISAO-MHT-140MM 5UN	MADER HAND TOOLS	50/200

LIMAS PRECISÃO LIMAS PRECISIÓN PRECISION FILE SET



6 un
150 mm

Paralela | Paralela | Flat: 2 un
Meia-Cana | Media Caña | Half Round: 1 un
Triângular | Triángular | Triangle: 1 un
Quadrada | Cuadrada | Square: 1 un
Redonda | Redonda | Round: 1 un

N. Ref.	Descrição	Marca	Quant. Caixa
51632	LIMA-MEX-C/BICOLOR 6" 6PCS BL	MADER HAND TOOLS	6/48

LIMAS LIMAS FILES

Estojo
Estuche
Case



5 un

Paralela | Paralela | Flat: 2 un
- (H2) 200, (H1) 250 mm
Meia-Cana | Media Caña | Half Round: 1 un
- (H1) 200 mm
Triângular | Triángular | Triangle: 1 un
- (H2) 150 mm
Redonda | Redonda | Round: 1 un
- (H1) 150 mm

N. Ref.	Descrição	Marca	Quant. Caixa
51635	LIMAS-MHT-5UN	MADER HAND TOOLS	24

LIXA LIJA SANDING PAPERS

MADEIRA /METAL
MADERA /METAL
WOOD /METAL

533 x 76mm



Descrição:	Lixa - Madeira - 533x76mm		
Marca:	Mader Hand Tools		
N. Re.	Especificação		Quant. Caixa:
61085	Grão - Gr40 - 5 un		20
61086	Grão - Gr60 - 5 un		20
61087	Grão - Gr80 - 5 un		20
61088	Grão - Gr120 - 5 un		20



Gr40 5un



Gr60 5un



Gr80 5un



Gr120 5un

LIXA LIJA SANDING PAPERS

MADEIRA 5un
MADERA
WOOD

230 x 280mm



Descrição:	Lixa - Madeira		
Marca:	Mader Hand Tools		
N. Ref.	Especificação		Quant. Caixa:
31258	Grão - Gr40 - 5 un		160/160
31259	Grão - Gr60 - 5 un		250/250
31260	Grão - Gr80 - 5 un		250/250
31261	Grão - Gr100 - 5 un		160/160
31262	Grão - Gr120 - 5 un		250/250



Gr40



Gr60



Gr80



Gr100



Gr120

LIXA LIJA SANDING PAPERS

MADEIRA 50un
MADERA
WOOD

230 x 280mm



Descrição:	Lixa - Madeira		
Marca:	Mader Hand Tools		
N. Ref.	Especificação		Quant. Caixa:
61080	Grão - Gr40 - 50 un		20/20
61081	Grão - Gr60 - 50 un		20/20
61082	Grão - Gr80 - 50 un		20/20
61083	Grão - Gr100 - 50 un		20/20
61084	Grão - Gr150 - 50 un		20/20

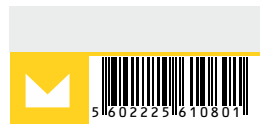

Gr40



Gr60



Gr80



Gr100



Gr150

LIXA
LIJA
SANDING PAPERS

METAL 1un
230 x 280mm

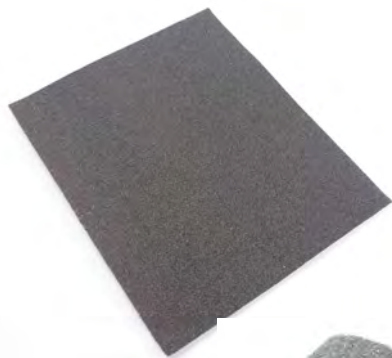

Descrição: Lixa - Metal		
Marca: Mader Hand Tools		
N. Ref.	Especificação	Quant. Caixa:
31270	00-Grão - Gr40 - 1 un	50/160
31273	0-Grão - Gr60 - 1 un	50/160
31275	1,5-Grão - Gr100 - 1 un	50/160

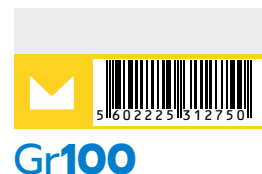

LIXA
LIJA
SANDING PAPERS

METAL 5un
230 x 280mm



Descrição: Lixa - Metal		
Marca: Mader Hand Tools		
N. Ref.	Especificação	Quant. Caixa:
31250	Grão - Gr40 - 5 un	20/160
31251	Grão - Gr60 - 5 un	20/160
31252	Grão - Gr80 - 5 un	20/160
31253	Grão - Gr100 - 5 un	20/160
31254	Grão - Gr150 - 5 un	20/250

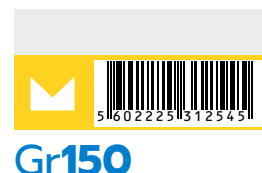

RASPADOR METÁLICO
RASCADOR METÁLICO
METAL SCRAPER

CABO LONGO
CABLE LARGO
LONG HANDLE

LÂMINA P/ RASPADOR
LÂMINA P/ RASCADOR
SCRAPER BLADE

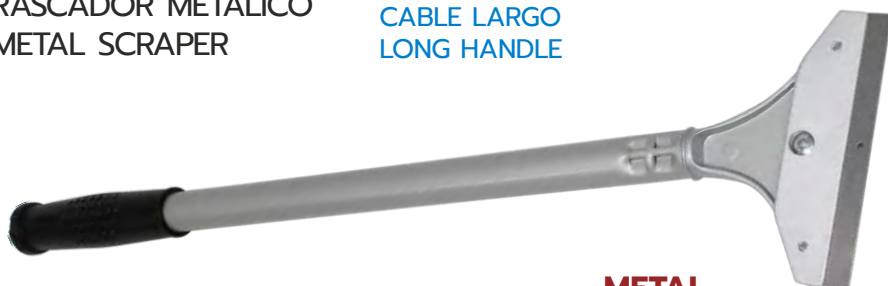

METAL



Descrição: Raspador		
Marca: Mader Hand Tools		
N. Ref.	Especificação	Quant. Caixa:
20097	Cabo Longo - 102x320mm	6/72
20098	Lâmina - 102x14mm - 10un	12/144

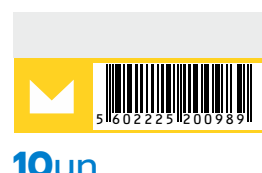

MÁQUINA AGRAFAR GRAPADORA STAPLE GUN

C/ REGULAÇÃO DE PRESSÃO
CON REGULACIÓN DE PRESIÓN
WITH PRESSURE REGULATION

Agrafes /Grapas /Staples

ref. 53



200 Agrafes
Grapas
Staples

4mm - 8mm



100 Agrafes
Grapas
Staples

4mm - 14mm

Descrição:	Máquina Agrafar	
Marca:	Mader Hand Tools	
N. Ref.	Especificação	Quant. Caixa:
61216	4 - 8 mm - 200 un	16/32
61215	4 - 14 mm - 100 un	5/20

AGRAFES GRAPAS STAPLES

ref. 53



6mm
1000un



8mm
500un

Descrição:	Agrafe p/ Máquina Agrafar Manual	
Marca:	Mader Hand Tools	
N. Ref.	Especificação	Quant. Caixa:
33210	53/ 6mm - 1000 un	20/100
33211	53/ 8mm - 500 un	20/100
33212	53/ 10mm -500 un	20/100
33213	53/ 12mm - 500 un	20/100



10mm
500un



12mm
500un

MEDIDOR A LASER MEDIDOR DE LÁSER LASER DISTANCE METER



LASER VERMELHO LÁSER ROJO RED LASER



0.05 - 50m

Precisão / Precisión / Precision	± 2mm
Autonomia / Autonomy	8000x Medição Simples
Bateria / Batería / battery	2x 15V AAA

N. Ref.	Descrição	Marca	Quant. Caixa
84660	MEDIDOR LASER-MHT-50M VERMELHO	MADER HAND TOOLS	20/80

Medição de área
Medição de volume
Teorema de Pitágoras
Adiciona e subtrai medidas

Medición de la superficie
Medición del volumen
Teorema de Pitágoras
Sumar y restar medidas

Area measurement
Volume measurement
Pythagoras theorem
Add and subtract measurements

NÍVEL A LASER NIVEL DE LÁSER LASER LEVEL



LASER VERDE LÁSER VERDE GREEN LASER



20m

Precisão / Precisión / Precision	± 3mm/10m
Autonomia / Autonomy	4h
Bateria / Batería / battery	2x 15V AA
Classificação IP / Clasificación IP / IP Rating	IP54

N. Ref.	Descrição	Marca	Quant. Caixa
30540	NIVEL LASER-MHT-20M CRUZ VERDE	MADER HAND TOOLS	30



Auto-Nivelamento: 4° ± 1°
Autonivelación: 4° ± 1°
Self-Leveling: 4° ± 1°

NÍVEL ALUMÍNIO NIVEL ALUMINIO ALUMINUM LEVEL

VOLA



GARANTIA ANTI-CHOQUE

Os níveis de alumínio tubulares têm a secção em **caixão reforçado**, que lhes confere uma maior resistência e são revestidos com uma camada dura **resistente à abrasão** em epoxy amarelo. A precisão destes níveis requer uma elevação entre 0,5 e 1,0 mm por metro, para centrar a bolha na posição normal de trabalho. Equipados com **3 bolhas de cor anti-choque** (1 vertical, 1 horizontal e 1 declive 45°), que estão ligadas permanentemente ao corpo, para uma precisão consistente na posição normal de trabalho.

Reversibilidade boa (possuem a mesma exatidão ao serem usados invertidos). Tem **escala graduada** em milímetros. Garantia de 5 anos contra quebra e vazamento (bolhas).



40cm



50cm



60cm



80cm



100cm



***120cm**



***150cm**



***180cm**

*** NÃO TÊM ESCALA GRADUADA**

Descrição: Nível Graduado Tubular - Alumínio
Marca: Vola

N. Ref.	Especificação	Quant. Caixa:
91025	245 - 3 Bolhas - 40 cm	10
91030	245 - 3 Bolhas - 50 cm	10
91035	245 - 3 Bolhas - 60 cm	10
91040	245 - 3 Bolhas - 80 cm	10
91045	245 - 3 Bolhas - 100 cm	10
91065	245 - 3 Bolhas - 120 cm*	10
91070	245 - 3 Bolhas - 150 cm*	10
91073	245 - 3 Bolhas - 180 cm*	10

ESQUADRO ESCUADRA SQUARE

VOLA



25cm



30cm

Descrição: Esquadro Graduado - Alumínio
Marca: Vola

N. Ref.	Especificação	Quant. Caixa:
91090	270 - 25 cm	12
91092	270 - 30 cm	12
91094	270 - 35 cm	12
91096	270 - 40 cm	12
91098	270 - 50 cm	12



35cm



40cm



50cm

NÍVEL ALUMÍNIO NIVEL ALUMINIO ALUMINUM LEVEL

GRADUADO GRADUATE



3 BOLHAS
BURBUJAS
BUBBLES



50cm



60cm



80cm



100cm

Descrição: Nível Graduado Tubular - Alumínio

Marca: Mader Hand Tools

N. Ref.	Especificação	Quant. Caixa:
30525	92 - 3 Bolhas - 50 cm	50
30526	92 - 3 Bolhas - 60 cm	50
30523	92 - 3 Bolhas - 80 cm	30
30522	92 - 3 Bolhas - 100 cm	30

Equipados com **3 bolhas de cor anti-choque**

(1 vertical, 1 horizontal e 1 declive 45°),

que estão ligadas permanentemente ao corpo, para uma precisão consistente na posição normal de trabalho.

Reversibilidade boa (possuem a mesma exatidão ao serem usados invertidos).

Tem **escala graduada** em milímetros.

NÍVEL ALUMÍNIO NIVEL ALUMINIO ALUMINUM LEVEL

MAGNÉTICO MAGNETIC



3 BOLHAS
BURBUJAS
BUBBLES



60cm



80cm



100cm



120cm

Descrição: Nível - Alumínio

Marca: Mader Hand Tools

N. Ref.	Especificação	Quant. Caixa:
30532	3 Bolhas - 60 cm	60
30533	3 Bolhas - 80 cm	30
30534	3 Bolhas - 100 cm	30
30535	3 Bolhas - 120 cm	20

Equipados com **3 bolhas de cor anti-choque**

(1 vertical, 1 horizontal e 1 declive 45°),

que estão ligadas permanentemente ao corpo, para uma precisão consistente na posição normal de trabalho.

Magnético

ESQUADRO
ESCUADRA
TRY SQUARE

Alumínio
Aluminio
Aluminium



30510



5602225305103



350 mm



30511



5602225305110

500 mm

N. Ref.	Descrição	Marca	Quant. Caixa
30510	ESQUADRO-MHT-GRAD ALUM 350MM	MADER HAND TOOLS	6/48
30511	ESQUADRO-MHT-GRAD ALUM 500MM	MADER HAND TOOLS	6/48

ESQUADRO
ESCUADRA
TRY SQUARE

Aço
Acero
Steel



30512



5602225305127



300 mm



30513



5602225305134

350 mm

N. Ref.	Descrição	Marca	Quant. Caixa
30512	ESQUADRO-MHT-GRAD AÇO 300MM	MADER HAND TOOLS	6/48
30513	ESQUADRO-MHT-GRAD AÇO 350MM	MADER HAND TOOLS	6/36

ESQUADRO COMBINADO
ESCUADRA COMBINADA
COMBINATION SQUARE

Graduado
Graduate



30514



5602225305141



300 mm

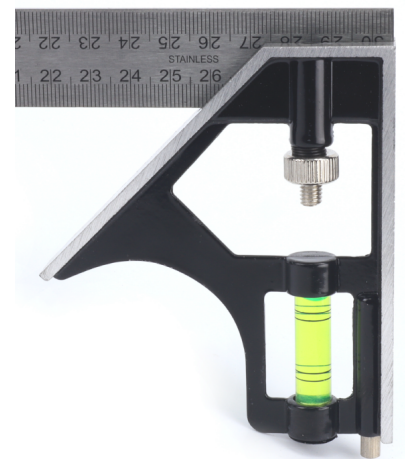

N. Ref.	Descrição	Marca	Quant. Caixa
30514	ESQUADRO COMBIN-MHT-GRAD 300MM	MADER HAND TOOLS	6/60

ESQUADRO COM BASE
ESCUADRA CON BASE
SQUARE WITH BASE



Metal



600x300mm



800x400mm

N. Ref.	Descrição	Marca	Quant. Caixa
30515	ESQUADRO C/BASE-MHT-600X300MM	MADER HARDWARE	6/1
30516	ESQUADRO C/BASE-MHT-800X400MM	MADER HARDWARE	6/1

PAQUÍMETRO
CALIBRADOR
VERNIER CALIPER

INOX

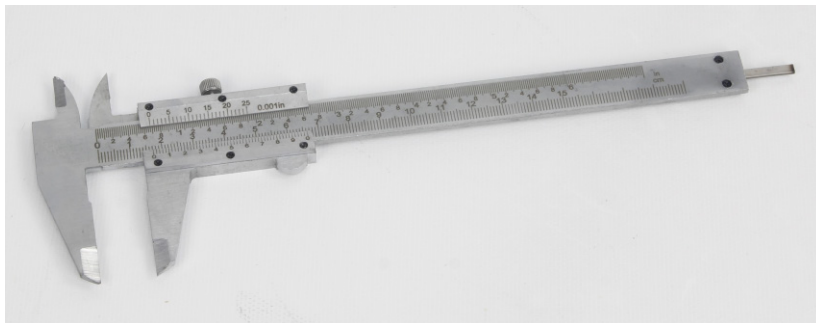

Medição: mm / in
Interiores e Exteriores
Medida: mm / in
Interior y Exterior
Measurement: mm / in
Interior and Exterior

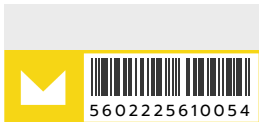

150 mm

Botão de Bloqueio e Roda de Ajuste
Botón de Bloqueo y Rueda de Ajuste
Lock Button and Adjusting Wheel

N. Ref.	Descrição	Marca	Quant. Caixa
61005	PAQUIMETRO-MHT-150MM	MADER HAND TOOLS	25/50

PAQUÍMETRO
CALIBRADOR
CALIPER

INOX

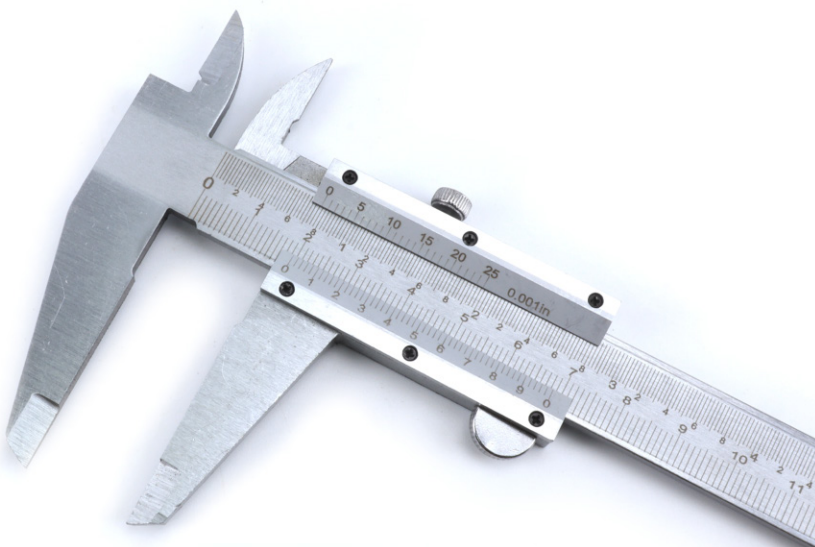

Medição: mm / in
Interiores e Exteriores
Medida: mm / in
Interior y Exterior
Measurement: mm / in
Interior and Exterior



200mm

Botão de Bloqueio e Roda de Ajuste
Botón de Bloqueo y Rueda de Ajuste
Lock Button and Adjusting Wheel

N. Ref.	Descrição	Marca	Quant. Caixa
60990	PAQUIMETRO-MHT-200MM	MADER HAND TOOLS	50/50

FITA MÉTRICA CINTA MÉTRICA MEASURING TAPE



2 TRAVÃO
FRENO
BRAKE



16mm x 3m



19mm x 5m

1 TRAVÃO
FRENO
BRAKE



25mm x 5m



25mm x 8m

Descrição: Fita Métrica

Marca: Mader Hand Tools

N. Ref. Especificação

84645 2 Travão - 16 mm x 3 m

Quant. Caixa:

12/120

84646 2 Travão - 19 mm x 5 m

12/120

84643 1 Travão - 25 mm x 5 m

10/100

84644 1 Travão - 25 mm x 8 m

6/60

FITA MÉTRICA CINTA MÉTRICA MEASURING TAPE



3 TRAVÕES
FRENOS
BRAKES



16mm x 3m



19mm x 5m



25mm x 8m



32mm x 10m

Descrição: Fita Métrica

Marca: Mader Hand Tools

N. Ref. Especificação

84600 3 Travões - 16 mm x 3 m

Quant. Caixa:

12/120

84601 3 Travões - 19 mm x 5 m

10/60

84602 3 Travões - 25 mm x 8 m

6/60

84608 3 Travões - 32 mm x 10 m

6/48

FITA MÉTRICA FLEXÓMETRO MEASURE TAPE

Travão » 1
Freno » 1
Brake » 1



19mm x 5m

Expositor com 12 un
Expositor con 12 un
Display stand with 12 un

N. Ref.	Descrição	Marca	Quant. Caixa
84609	FITA MÉTRICA-MHT-5MX19MM - EXPOSITOR 12un	MADER HAND TOOLS	1/15

FITA MÉTRICA CINTA MÉTRICA MEASURING TAPE

FIBRA DE VIDRO FIBRA DE VIDRIO FIBERGLASS



Descrição:	Fita Métrica	
Marca:	Mader Hand Tools	
N. Ref.	Especificação	Quant. Caixa:
84617	Fibra de Vidro - 20 m	60
84623	Fibra de Vidro - 30 m	60
84624	Fibra de Vidro - 50 m	30



20m



30m



50mm

ESCORA EXTENSÍVEL
 PUNTALE EXTENSIBLE
 EXTENSIBLE ACROW PROP

BASES ANTIDERRAPANTES
 BASES ANTIDESLIZANTES
 ANTI-SLIP PADS

AJUSTÁVEL A 180°
 AJUSTABLE A 180°
 ADJUSTABLE TO 180°

CAPACIDADE CARGA 60KG
 CAPACIDAD DE CARGA 60KG
 LOAD CAPACITY 60KG



ALUMÍNIO
 ALUMINIUM

ESPONJA
 SPONGE

AÇO
 ACERO
 STEEL

TPE / BORRACHA
 GOMA
 RUBBER



69 - 115cm



100 - 175cm



160 - 290cm

Descrição: Escora Extensível

Marca: Mader Hand Tools

N. Ref.	Especificação	Quant. Caixa:
61457	69-115cm	4/8
61458	100-175cm	4/8
61459	160-290cm	4/8

GRAMPO DE CARPINEIRO ABRAZADERA DE CARPINTERO CARPENTER'S CLAMP



1/2"

3/4"



60993



5602225609935



60994



5602225609942

N. Ref.	Descrição	Marca	Quant. Caixa
60993	GRAMPO CARPINEIRO-MHT-1/2"	MADER HAND TOOLS	40
60994	GRAMPO CARPINEIRO-MHT-3/4"	MADER HAND TOOLS	30

GRAMPO DE COFRAGEM ABRAZADERA DE COFRADO FORMWORK CLAMP

Ferro
Hierro
Iron

Espessura da barra: 30 x 6 mm
Espesor de la barra: 30 x 6 mm
Bar thickness: 30 x 6 mm



800 mm

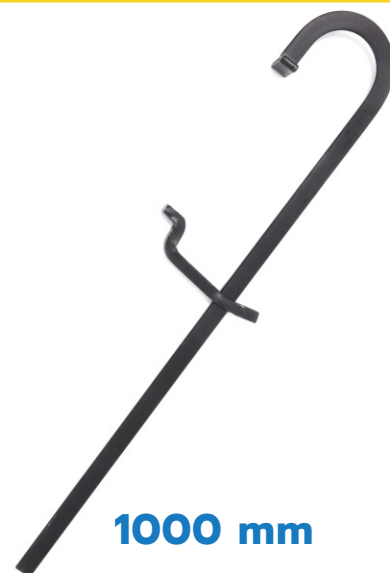

1000 mm



60998



5602225609980



60999



5602225609997

Medidas / Measures

Interior

800 x 120 mm

Interior

1000 x 155 mm

N. Ref.	Descrição	Marca	Quant. Caixa
60998	GRAMPO COFRAGEM-MHT-800MM	MADER HAND TOOLS	10
60999	GRAMPO COFRAGEM-MHT-1000MM	MADER HAND TOOLS	10

GRAMPO APERTO TORNILLO APRIETE CLAMP



200mm



250mm

50mm



80mm



250mm



300mm



400mm



500mm



1000mm

120mm



Descrição: Grampo Aperto

Marca: Mader Hand Tools

N. Ref.	Especificação	Quant. Caixa:
61070	50 x 200 mm	50
61071	50 x 250 mm	50
61072	80 x 250 mm	20
61073	80 x 300 mm	20
61074	80 x 400 mm	10
61075	80 x 500 mm	10
61067	120 x 1000 mm	6

GRAMPO TORNILLO CLAMP



110mm

Ref: 100



170mm

Ref: 150



230mm

Ref: 225



300mm



600mm

MOLA MUELLE SPRING CLAMP



TIPO
TYPE F



Descrição: Grampo

Marca: Mader Hand Tools

N. Ref.	Especificação	Quant. Caixa:
61077	Mola - 100 - 110 mm	50/200
61078	Mola - 150 - 170 mm	25/100
61079	Mola - 225 - 230 mm	25/100
61068	tipo F - 300 mm	6/36
61069	tipo F - 600 mm	6/36

CHAVE DE DOBRAR FERRO
LLAVE GRIFA DOBLAR FERRALLA
IRON BAR BENDER



6/8mm
400x12mm



8/10mm
450x12mm

N. Ref.	Descrição	Marca	Quant. Caixa
61037	CH DOBRAR FERRO-MHT-400-6X8MM	MADER HAND TOOLS	1/1
61039	CH DOBRAR FERRO-MHT-450-8X10MM	MADER HAND TOOLS	1/1

MÁQUINA MASTIQUE PISTOLA DE CARTUCHOS SILICONA SKELETON CAULKING GUN



9" 1º PREÇO



CROMADA
CROMADO
CHROME



9"



TIPO JAPÃO



9"



QUALIDADE



9"



ALUMÍNIO
ALUMINUM
QUALIDADE



9"



ALUMÍNIO
ALUMINUM

PROFISSIONAL



15"

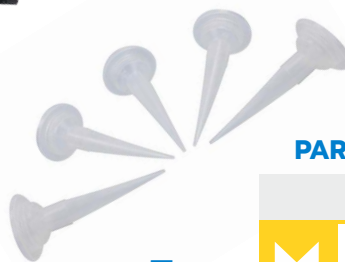

5un

PARA / TO 42251



Descrição: Pistola Mastique

Marca: Mader Hand Tools

N. Ref.	Especificação	Quant. Caixa:
61200	Tipo Japão - 9"	24
42240	1565 - 9"	24
42241	726 - 9" Cromada	24
42247	Qualidade - 9"	24
42249	Qualidade - 9" Alumínio	12
42251	Profissional - 15" Alumínio	12
42252	Bicos para 42251 - 5un	75

DESENTUPIDOR DE CANOS
LIMPIADORA DE DESAGUES
DRAIN CLEANER



Ø30mm x 4m
Haste: Ø6mm

Especificações / Especificaciones / Specifications

Flexível / Flexible

N. Ref.	Descrição	Marca	Quant. Caixa
60995	DESENTUPIDOR CANOS-MHT-4MX6MM	MADER HAND TOOLS	10/40

DESENTUPIDOR DE CANOS
LIMPIADORA DE DESAGUES
DRAIN CLEANER

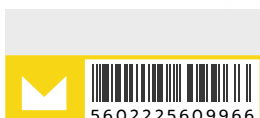

Especificações / Especificaciones / Specifications

Vácuo / Succión / Suction

N. Ref.	Descrição	Marca	Quant. Caixa
60996	DESENTUPIDOR CANOS-MHT-VÁCUO	MADER HAND TOOLS	12/24

PISTOLA ESPUMA PISTOLA ESPUMA FOAM GUN



Descrição: Pistola p/ Espuma
Marca: Mader Hand Tools
N. Ref. Especificação
63271 CY-066

Quant. Caixa:
20



516022251632711

JOELHEIRA RODILLERA KNEE PAD



Borracha
Goma
Rubber



516022251562674



GEL



516022251610948

Descrição: Joelheira
Marca: Mader Hand Tools
N. Ref. Especificação
56267 Borracha
61094 Gel

Quant. Caixa:
10/40
12

Tamanho /Tamaño / Size: **UNIVERSAL**
Ajuste Seguro /Secure Fit

BETUMADEIRA ESPÁTULA SCRAPER

MULTIUSOS
MULTIUSOS
MULTI-PURPOSE



6in1

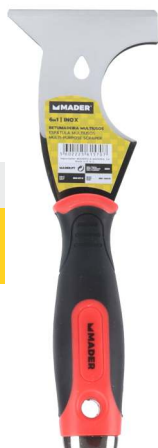

INOX



16in1



INOX



25mm



50mm



75mm



100mm

LARGA
ANCHA
LARGE



INOX



150mm



200mm



250mm



300mm

Descrição: **Betumadeira - Inox**

Marca: **Mader Hand Tools**

N. Ref. Especificação

61570 Multiusos - 6in1

61571 Multiusos - 16in1

61560 25 mm

61561 50 mm

61562 75 mm

61563 100 mm

61564 Larga - 150 mm

61565 Larga - 200 mm

61566 Larga - 250 mm

61567 Larga - 300 mm

61575 Angular - 155x60 mm

Quant. Caixa:

12

12

12

12

12

12

12

12

12

12

12

ANGULAR
ANGULAR
HALF ROUND



INOX



155x60mm

BETUMADEIRA ESPÁTULA SCRAPER



INOX

CABO DE BORRACHA MANGO EN GOMA RUBBER HANDLE



25mm
1"



50mm
2"



75mm
3"



100mm
4"



125mm
5"

Descrição: Betumadeira - Inox

Marca: Mader Hand Tools

N. Ref.	Especificação	Quant. Caixa:
61255	C. Borracha - 1" - 25mm	12/12
61256	C. Borracha - 2" - 50mm	12/240
61257	C. Borracha - 3" - 75mm	12/240
61258	C. Borracha - 4" - 100mm	12/240
61259	C. Borracha - 5" - 125mm	12/120

COLHERIM PEDREIRO PALETIN ALBAÑIL BRICKLAYING TROWEL



PONTA REDONDA
PUNTA REDONDA
ROUND TIP

AÇO **CABO DE MADEIRA**
ACERO **MANGO EN MADERA**
STEEL **WOODEN HANDLE**

CANTO CORTADO
ESQUINA CORTADA
CUT CORNER



150mm 6"

AÇO **CABO DE MADEIRA**
ACERO **MANGO EN MADERA**
STEEL **WOODEN HANDLE**

CANTO RETO
ESQUINA RECTA
STRAIGHT CORNER



PONTA BICUDA
PUNTA PICUDA
POINTED TIP

PONTA REDONDA
PUNTA REDONDA
ROUND TIP



150mm 6"



150mm 6"

Descrição: Colherim Pedreiro

Marca: Mader Hand Tools

N. Ref.	Especificação	Quant. Caixa:
30672	Aço - C. Madeira - P Redonda Canto Cortado - 6" - 150mm	12/120
98876	Aço - Cabo Madeira Ponta Bicuda - 150mm	1
98877	Ponta Redonda - 150mm	12

COLHER PEDREIRO
PALETIN ALBAÑIL
BRICKLAYING TROWEL

AÇO **PONTA REDONDA**
ACERO **PUNTA REDONDA**
STEEL **ROUND TIP**

CANTO RETO
ESQUINA RECTA
STRAIGHT CORNER

CABO DE MADEIRA
MANGO EN MADERA
WOODEN HANDLE



200mm
8"



230mm
9"



215mm
8-½"



220mm
8-½"



240mm
9-½"



CABO ABS+TPR /MANGO ABS+TPR /ABS+TPR HANDLE

Descrição: Colher Pedreiro - Ponta Redonda

Marca: Mader Hand Tools

N. Ref. Especificação Quant. Caixa:

Aço - Cabo Madeira

30673	8" - 200mm	12/120
30674	9" - 230mm	12/120
98881	215mm	1
98882	220mm	1
98883	240mm	1

Aço Carbono - Cabo ABS+TPR

61580	125 mm	12
61581	150 mm	12
61582	175 mm	12
61583	200 mm	12
61584	225 mm	12



125mm



150mm



175mm



200mm



225mm

COLHER PEDREIRO
PALETIN ALBAÑIL
BRICKLAYING TROWEL

AÇO **CABO DE MADEIRA**
ACERO **MANGO EN MADERA**
STEEL **WOODEN HANDLE**

CANTO CORTADO **PONTA REDONDA**
ESQUINA CORTADA **PUNTA REDONDA**
CUT CORNER **ROUND TIP**

Descrição: Colher Pedreiro

Marca: Mader Hand Tools

N. Re Especificação Quant. Caixa:

Aço - C. Madeira - P Redonda

30670	Canto Cortado - 8" - 200mm	12/120
30671	Canto Cortado - 9" - 225mm	12/120



200mm
8"



230mm
9"

COLHER PEDREIRO PALETIN ALBAÑIL BRICKLAYING TROWEL

AÇO CABO DE MADEIRA
ACERO MANGO EN MADERA
STEEL WOODEN HANDLE

CANTO CORTADO PONTA REDONDA
ESQUINA CORTADA PUNTA REDONDA
CUT CORNER ROUND TIP

Descrição: Colher Pedreiro

Marca: Mader Hand Tools

N. Ref. Especificação Quant. Caixa:

Aço - C. Madeira - P Redonda

98879	Canto Cortado - 215mm	12
98887	Canto Cortado - 220mm	1
98888	Canto Cortado - 240mm	1



215mm
8-1/2"



220mm
8-1/2"



240mm
9-1/2"

TALOCHA DE PEDREIRO LLANA DE PEDRERO PLASTERING TROWEL

AÇO CABO DE PLÁSTICO
ACERO MANGO EN PLASTICO
STEEL PLASTIC HANDLE



280x130mm

DENTADA
W/ TEETH



LISA
FLAT



280x130mm



280x125mm

AÇO CABO ABS+TPR
ACERO MANGO ABS+TPR
STEEL ABS+TPR HANDLE



280x125mm

INOX

CABO DE BORRACHA
MANGO EN GOMA
RUBBER HANDLE



DENTADA
W/ TEETH



280x114mm



LISA
FLAT



280x114mm

Descrição: Talocha Pedreiro

Marca: Mader Hand Tools

N. Ref. Especificação Quant. Caixa:

56248	Aço - Dent. - C. Plast. - 280mm	12/60
56247	Aço - Lisa - C. Plast. - 280mm	12/60
61595	Aço - Dent. - C. ABS+TPR - 280mm	12
61590	Aço - Lisa - C. ABS+TPR - 280mm	12
56232	Inox - Dent. - C. Borrac. - 280mm	12/48
56231	Inox - Lisa - C. Borrac. - 280mm	12/48

TALOCHA DE PEDREIRO

LLANA DE PEDREIRO
PLASTERING TROWEL

PLÁSTICA
PLASTIC

CIMENTO
CEMENTO
CONCRETE



355x55x55mm

EXTERIOR
OUTSIDE



Pilar
Cornerstone



355x55x55mm

INTERIOR
INSIDE



330x30mm

Nº1



380x50mm

Nº2



380x70mm

Nº3



Cantos
Esquina
Corner



265x160mm

Nº1



340x217mm

Nº2



415x260mm

Nº3



Bico /Pico /Beak



265x160mm

Nº1



Descrição: Talocha Pedreiro

Marca: Mader Hand Tools

N. Ref.	Especificação	Quant. Caixa:
99997	p/ Pilar - Exterior	25/25
99996	p/ Pilar - Interior	50/50
99970	Plástica - Cantos - Nº1	20/20
99971	Plástica - Cantos - Nº2	50/50
99972	Plástica - Cantos - Nº3	25/25
99994	Plástica - Nº1	25
99995	Plástica - Nº2	30
99993	Plástica - Nº3	15
99992	Plástica - Bico - Nº1	1

61600 Poliuretano - 240x120 mm 60

61601 Poliuretano - 280x140 mm 60

61602 Poliuretano - 320x180 mm 60



POLIURETANO
POLYURETHANE



240x120mm



280x140mm



320x180mm

TALOCHA DE PEDREIRO

LLANA DE PEDRERO
PLASTERING TROWEL

CABO PLÁSTICO
MANGO PLÁSTICO
PLASTIC HANDLE



ESPONJA
SPONGE
Nº1



265x160mm



CABO PLÁSTICO / ALUMINÍO
MANGO PLÁSTICO / ALUMINIO
PLASTIC / ALUMINIUM HANDLE



ESPONJA
SPONGE



240x100mm

CABO PLÁSTICO / PLÁSTICO
MANGO PLÁSTICO / PLÁSTICO
PLASTIC / PLASTIC HANDLE



BORRACHA
GOMA
RUBBER



240x100mm

CABO PLÁSTICO / ALUMINÍO
MANGO PLÁSTICO / ALUMINIO
PLASTIC / ALUMINIUM HANDLE



BORRACHA/ESPONJA
GOMA/ESPONJA
RUBBER/SPONGE

Descrição:	Talocha Pedreiro		
Marca:	Mader Hand Tools		
N. Ref.	Especificação	Quant.	Caixa:
20575	Esponja - C. Plast. - Nº 1	25/25	
56233	Esponja - C. Plast./Alum. - 240mm	24/24	
56246	Borracha - C. Plast. - 240mm	12/60	
56235	Borr./Esp. -C. Plast./Alum. -240mm	24/24	
56234	Borr./Esp. -C. Plast./Alum. -300mm	10/50	



240x100mm



300x100mm

ESPONJA DE PEDREIRO

ESPONJA DE PEDRERO
MASONRY SPONGE



170mm



170 x 110 x 55 mm

Descrição:	Esponja p/ Pedreiro		
Marca:	Mader Hand Tools		
N. Ref.	Especificação	Quant.	Caixa:
56272	Amarela - 170x110x55mm	1	
56273	Amarela - 190x140x60mm	1	

190mm



190 x 140 x 60 mm

PÓ » MARCADOR
POLVO » TRAZADOR
POWDER » CHALK LINE



115gr

Descrição: **Pó Marcador**
 Marca: **Mader Hand Tools**
 N. Ref. Especificação Quant. Caixa:
52215 Azul - 115 gr 12/120

MARCADOR DE RETAS
CORDEL DE TRAZADO
CHALK LINE REEL



30 m

COM NÍVEL
CON NIVEL
WITH LEVEL

Descrição: **Marcador de Retas**
 Marca: **Mader Hand Tools**
 N. Ref. Especificação Quant. Caixa:
52222 Marcador + Nível - 30m 50/100

KIT MARCADOR DE RETAS
KIT CORDEL DE TRAZADO
CHALK LINE REEL SET

Marcador Retas /Cordel Trazado /Chalk Line Reel:
30m
 Pó » Marcador /Polvo » Trazado /Chalk Line Powder:
115g
 Nível /Nível /Level



3 un

COM NÍVEL
CON NIVEL
WITH LEVEL

Descrição: **Marcador de Retas - Kit**
 Marca: **Mader Hand Tools**
 N. Ref. Especificação Quant. Caixa:
52221 Marcador + Pó + Nível - 3 un 12/60

FIO » MARCADOR

HILO » CORDEL TRAZADO
REEL BUILDERS LINE



75m

Descrição: Fio Marcador

Marca: Mader Hand Tools

N. Ref. Especificação

61019 Amarelo - 75 m

Quant. Caixa:

25/100

FIO » POLIPROPILENO

HILO » POLIPROPILENO
LINE » POLYPROPYLENE



150m

Descrição: Fio Polipropileno

Marca: Mader Hand Tools

N. Ref. Especificação

61017 150 m

Quant. Caixa:

15/150

PRUMO

PLOMADA
PLUMB

AÇO
ACERO
STEEL



300g

Descrição: Prumo

Marca: Mader Hand Tools

N. Ref. Especificação

30500 300 g - 5 m

Quant. Caixa:

10/60

LÁPIS CARPINTEIRO E AFIADORA

LÁPIZ CARPINTERO Y SACAPUNTAS
CARPINTER PENCIL AND SHARPENER



4 + 1un

Descrição: Lápis Carpinteiro

Marca: Mader Hand Tools

N. Ref. Especificação

31572 c/ Afiadeira - 5 un

Quant. Caixa:

12/60

BALDE PLÁSTICO CUBO PLÁSTICO PLASTIC BUCKET

Plástico
Plastic

10 L

15 L



Medidas / Measures

Ø 26 x 25 c

Ø 31 x 28 cm

N. Ref.	Descrição	Marca	Quant. Caixa
99055	BALDE PLÁSTICO P/CONST 10LT	MADER	1/25
99056	BALDE PLÁSTICO P/CONST 15LT	MADER	1/25

CELHA PRETA CAPAZO NEGRO BLACK CARRYCOT

Plástico
Plastic



CAP26

CAP42

CAP55

22 L

38 L

52 L

Ø 35 x 30 cm

Ø 42 x 33 cm

Ø 53 x 30 cm



N. Ref.	Descrição	Marca	Quant. Caixa
99900	CELHA / CAPAZO NEGRO REFº23	SEM MARCA	1/12
99901	CELHA / CAPAZO NEGRO REFº38	SEM MARCA	1/12
99902	CELHA / CAPAZO NEGRO REFº55	SEM MARCA	12

GAMELA PARA CIMENTO BANDEJA PARA HORMIGÓN CEMENT TRAY

com PEGAS
con MANGOS
with HANDLES

7.5 L



15 L



35 L

Com aba
Con pestaña
With flap



Medidas / Measures

485 x 315 x 95 mm

490 x 405 x 105 mm

645 x 470 x 165 mm

Medidas / Measures

Base: 310 x 210 mm

Base: 365 x 285 mm

Base: 500 x 325 mm

N. Ref.	Descrição	Marca	Quant. Caixa
99991	GAMELA P/CIMENTO Nº1 7,5LT	PETRONIO	12
99058	GAMELA P/CIMENTO Nº2 15LT	MADER	25
71070	GAMELA P/CIMENTO Nº3 35LT	PETRONIO	1



MADER[®]

**HAND
TOOLS**

BY **STANLEY**[®]



2024



NÍVEL TORPEDO
NÍVEL TORPEDO
TORPEDO LEVEL

STANLEY

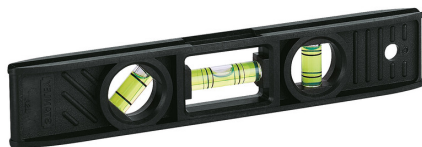

20cm



Alto impacto
High Impact



23cm



Alto impacto
High Impact



22cm



Magnético
Magnetic

N. Ref.	Descrição	Marca	Quant. Caixa
0-42-294	NÍVEL TORPEDO ALTO IMPATO 20CM	STANLEY	1
0-43-511	NÍVEL TORPEDO ALTO IMPATO 23CM	STANLEY	1
0-43-603	NÍVEL TORPEDO FATMAX 22CM MAGN	STANLEY	1

NÍVEL CLASSIC
NÍVEL CLASSIC
CLASSIC LEVEL

STANLEY



40cm



60cm



80cm



100cm



120cm



150cm



200cm



2 Bolhas
2 Burbujas
2 Bubbles

N. Ref.	Descrição	Marca	Quant. Caixa
STHT1-43102	NÍVEL CLASSIC 40 CM	STANLEY	1
STHT1-43103	NÍVEL CLASSIC 60 CM	STANLEY	1
STHT1-43104	NÍVEL CLASSIC 80 CM	STANLEY	1
STHT1-43105	NÍVEL CLASSIC 100CM	STANLEY	1
STHT1-43106	NÍVEL CLASSIC 120CM	STANLEY	60
STHT1-43107	NÍVEL CLASSIC 150CM	STANLEY	60
STHT1-43109	NÍVEL CLASSIC 200CM	STANLEY	1

NIVEL CLASSIC NIVEL CLASSIC CLASSIC LEVEL

Magnético
Magnético
Magnetic



3 Bolhas
3 Burbujas
3 Bubbles

STANLEY

40cm



60cm



80cm



120cm



N. Ref.	Descrição	Marca	Quant. Caixa
STHT1-43110	NIVEL CLASSIC 40CM MAGNETICO	STANLEY	1
STHT1-43111	NIVEL CLASSIC 60CM MAGNETICO	STANLEY	1
STHT1-43112	NIVEL CLASSIC 80CM MAGNETICO	STANLEY	1
STHT1-43114	NIVEL CLASSIC 120CM MAGNETICO	STANLEY	1

NÍVEL FATMAX NIVEL FATMAX FATMAX LEVEL

TRAPEZOIDAL



2 Bolhas
2 Burbujas
2 Bubbles

STANLEY

40cm



50cm



60cm



80cm



100cm



N. Ref.	Descrição	Marca	Quant. Caixa
1-42-312	NIVEL FATMAX MLH TRAPZO 40CM	STANLEY	1
1-42-313	NIVEL FATMAX MLH TRAPZO 50CM	STANLEY	1
1-42-314	NIVEL FATMAX MLH TRAPZO 60CM	STANLEY	1
1-42-315	NIVEL FATMAX MLH TRAPZO 80CM	STANLEY	1
1-42-316	NIVEL FATMAX MLH TRAP 100CM	STANLEY	4

FITA MÉTRICA
FLEXÓMETRO
MEASURING TAPE

Revestimento Tylon
Revestimiento de Tylon
Tylon coating



3mx13mm



STANLEY



Granel
Bulk



Blister

N. Ref.	Descrição	Marca	Quant. Caixa
1-30-687	FITA MÉTRICA-STA-3MX13MM TYLON	STANLEY	1/72
0-30-687	FITA MÉTR-STA-3MX13MM TYLON BL	STANLEY	1/36

FITA MÉTRICA
FLEXÓMETRO
MEASURING TAPE

Revestimento Tylon
Revestimiento de Tylon
Tylon coating



5mx19mm



STANLEY



Granel
Bulk



Blister

N. Ref.	Descrição	Marca	Quant. Caixa
1-30-697	FITA MÉTRICA-STA-5MX19MM TYLON	STANLEY	1/72
0-30-697	FITA MÉTR-STA-5MX19MM TYLON BL	STANLEY	1/36

FITA MÉTRICA
FLEXÓMETRO
MEASURING TAPE

Revestimento Tylon
Revestimiento de Tylon
Tylon coating



8mx25mm



STANLEY

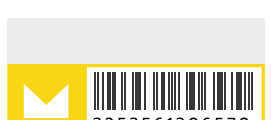

Granel
Bulk



Blister

N. Ref.	Descrição	Marca	Quant. Caixa
1-30-657	FITA MÉTRICA-STA-8MX25MM TYLON	STANLEY	1/12
0-30-657	FITA MÉTR-STA-8MX25MM TYLON BL	STANLEY	1/36

FITA LONGA CINTA LARGA LONG TAPE



STANLEY

10m



3253560342951

20m



3253560342968

30m



3253560342975

Fibra de vidro
Fibra de vidro
Fibreglass

N. Ref.	Descrição	Marca	Quant. Caixa
0-34-295	FITA LONGA FIBRA DE VIDRO 10M	STANLEY	1
0-34-296	FITA LONGA FIBRA DE VIDRO 20M	STANLEY	1
0-34-297	FITA LONGA FIBRA DE VIDRO 30M	STANLEY	1

FITA LONGA CINTA LARGA LONG TAPE



STANLEY

30m



3253562347923

60m



3253562347954

Fibra de vidro
Fibra de vidro
Fibreglass

N. Ref.	Descrição	Marca	Quant. Caixa
2-34-792	FITA MÉTRICA-STA-30M FIB VIDRO	STANLEY	4
2-34-795	FITA MÉTRICA-STA-60M FIB VIDRO	STANLEY	1

ESQUADRO DE CARPINTEIRO
ESCUADRA DE CARPINTERO
CARPENTER'S SQUARE

STANLEY

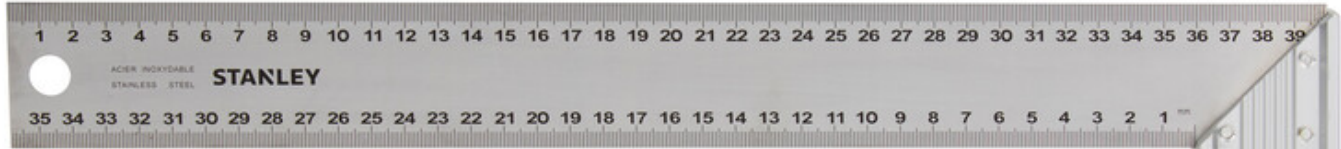

140x250mm



200x300mm



200x400mm



N. Ref.	Descrição	Marca	Quant. Caixa
1-45-685	ESQUADRO DE CARPINT 140X250MM	STANLEY	1
1-45-686	ESQUADRO DE CARPINT 200X300MM	STANLEY	6/24
1-45-687	ESQUADRO DE CARPINT 200X400MM	STANLEY	1

LÁPIS DE CARPINTEIRO
LÁPIZ DE CARPINTERO
CARPENTER'S PENCIL

STANLEY

Vermelho
Rojo
Red



176mm

N. Ref.	Descrição	Marca	Quant. Caixa
1-03-850	LAPIS CARPINTEIRO 176MM VERMEL	STANLEY	1

LÁPIS DE PEDREIRO
LÁPIZ DE MASON
MASON'S PENCIL

STANLEY

Verde
Green



176mm

N. Ref.	Descrição	Marca	Quant. Caixa
1-03-851	LAPIS DE PEDREIRO 176MM VERDE	STANLEY	1

MARCADOR-MINI MINI MARCADOR MINI MARKER

STANLEY

Ponta fina
Punta Fina
Fine Tip



72Un
Preta

N. Ref.	Descrição	Marca	Quant. Caixa
1-47-324	MARCADOR-MINI-P.FINA-PT EMB72	STANLEY	1

MARCADOR-MINI MINI MARCADOR MINI MARKER

STANLEY

Ponta fina
Punta Fina
Fine Tip



72Un
Sortido

N. Ref.	Descrição	Marca	Quant. Caixa
1-47-329	MARCADOR-MINI-P.FINA-ST EMB72	STANLEY	1

MARCADORES PONTA FINA MARCADORES DE PUNTA FINA FINE POINT MARKERS

STANLEY



2Un

N. Ref.	Descrição	Marca	Quant. Caixa
0-47-316	2 MARCADORES PONTA FINA-BLD	STANLEY	1

PRUMO PLOMADA PLUMB BOB



- 1x prumo, 30m
- 1x giz
- 1x nível
- 1x plomada, 30m
- 1x tiza
- 1x nível
- 1x plumb bob, 30m
- 1x chalk
- 1x level



N. Ref.	Descrição	Marca	Quant. Caixa
0-47-443	PRUMO 30M•GIZ•NIV•STA-0-47-443	STANLEY	1

PRUMO POWER PLOMADA POWER POWER PLUMB BOB



STANLEY



30m



N. Ref.	Descrição	Marca	Quant. Caixa
0-47-460	PRUMO POWER W 30M•STA-0-47-460	STANLEY	1

KIT POWER WINDER KIT POWER WINDER POWER WINDER KIT



STANLEY

- 1x prumo, 30m
- 1x giz
- 1x nível
- 1x plomada, 30m
- 1x tiza
- 1x nível
- 1x plumb bob, 30m
- 1x chalk
- 1x level



N. Ref.	Descrição	Marca	Quant. Caixa
0-47-465	KIT POWER WINDER 30M•GIZ•NÍVEL	STANLEY	1

CHAVE AJUSTÁVEL
LLAVE AJUSTABLE
ADJUSTABLE SPANNER

STANLEY



200mm



250mm



300mm



Bimaterial
Bi-Material



N. Ref.	Descrição	Marca	Quant. Caixa
0-90-948	CHAVE AJUSTAV BIMATERIA 200MM	STANLEY	2
0-90-949	CHAVE AJUSTAV BIMATERIA 250MM	STANLEY	6/12
0-90-950	CHAVE AJUSTAV BIMATERIA 300MM	STANLEY	2

TORNO BANCADA
TORNILLO DE BANCO
BENCH VICE

STANLEY

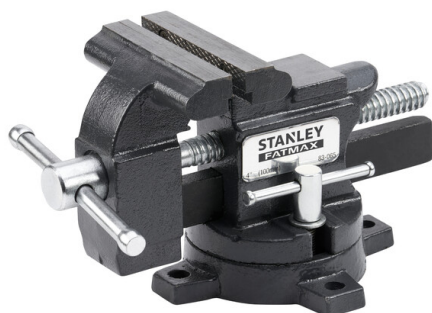

Serviço leve
Carga Ligera
Light Duty



Serviço Pesado
Carga Pesada
Heavy Duty



110mm



100mm



125mm



150mm

N. Ref.	Descrição	Marca	Quant. Caixa
1-83-065	TORNO BANC-SERVIÇO LEVE 110MM	STANLEY	5
1-83-066	TORNO BANC-SERVIÇ PESADO 100MM	STANLEY	5
1-83-067	TORNO BANC-SERVIÇ PESADO 125MM	STANLEY	5
1-83-068	TORNO BANC-SERVIÇ PESADO 150MM	STANLEY	5

MAÇO BI-MATERIAL
MAZA BI-MATERIAL
BI-MATERIAL STONING HAMMER

STANLEY

Quinas abauladas
Esquinas Redondeadas
Smashed Corners



1000g

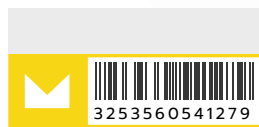

1250g

N. Ref.	Descrição	Marca	Quant. Caixa
STHTO-54126	MAÇO BI-MATE QUIN ABAUL 1000G	STANLEY	60
STHTO-54127	MAÇO BI-MATE QUIN ABAUL 1250G	STANLEY	60

MARTELO DE ORELHAS
MARTILLO DE GARRA
CLAW HAMMER

STANLEY

Fibra vidro
Fibra vidrio
Fiberglass



450g



560g

N. Ref.	Descrição	Marca	Quant. Caixa
STHTO-51309	MARTELO ORELHAS FIBRA VID 450G	STANLEY	60
STHTO-51310	MARTELO ORELHAS FIBRA VID 560G	STANLEY	60

MARTELO DE ORELHAS
MARTILLO DE GARRA
CLAW HAMMER

STANLEY

Fibra vidro
 Fibra vidro
 Fiberglass



750g



N. Ref.	Descrição	Marca	Quant. Caixa
STHTO-54123	MARTELO ORELHAS GRAFITE 750GR	STANLEY	2/12

MARTELO DE ORELHAS
MARTILLO DE GARRA
CLAW HAMMER

STANLEY

Fibra vidro
 Fibra vidro
 Fiberglass



650g



N. Ref.	Descrição	Marca	Quant. Caixa
STHTO-51311	MARTELO ORELHAS LATHAM 600G	STANLEY	1

MARTELO LATTHAMMER
MARTILLO LATTHAMMER
LATTHAMMER HAMMER

STANLEY

Borracha
 Goma
 Rubber



600g
Antivibração



N. Ref.	Descrição	Marca	Quant. Caixa
1-51-937	MARTELO LATTHAMMER ANTIVIB 600G	STANLEY	5

**AGRAFADOR
GRAPADOR
STAPLER**

STANLEY

para Agrafado Tipo A
para Grapa Tipo A
for Type A Staple



N. Ref.	Descrição	Marca	Quant. Caixa
6-TR45	AGRAFADOR PARA AGRAFO TIPO A	STANLEY	4

**AGRAFADOR
GRAPADOR
STAPLER**

STANLEY

para Agrafado Tipo G
para Grapa Tipo G
for Type G Staple



N. Ref.	Descrição	Marca	Quant. Caixa
TR110	AGRAFADOR PARA AGRAFO TIPO G	STANLEY	1

AGRAFO GRAPA STAPLE

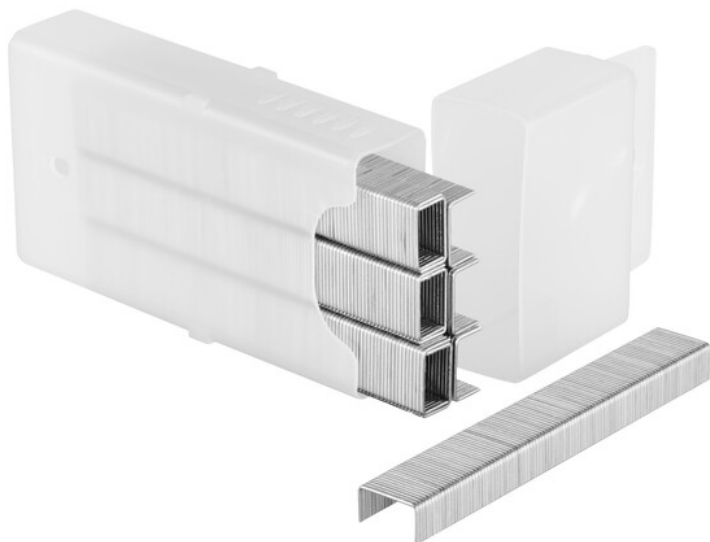

Tipo A Type A

STANLEY

6mm
1000Un



8mm
1000Un



10mm
1000Un



12mm
1000Un



14mm
1000Un



N. Ref.	Descrição	Marca	Quant. Caixa
1-TRA204T	AGRAFO-STA-6MM 1000UN TIPO A	STANLEY	1
1-TRA205T	AGRAFO-STA-8MM 1000UN TIPO A	STANLEY	6/49
1-TRA206T	AGRAFO-STA-10MM 1000UN TIPO A	STANLEY	5/40
1-TRA208T	AGRAFO-STA-12MM 1000UN TIPO A	STANLEY	1
1-TRA209T	AGRAFO-STA-14MM 1000UN TIPO A	STANLEY	1

AGRAFO GRAPA STAPLE

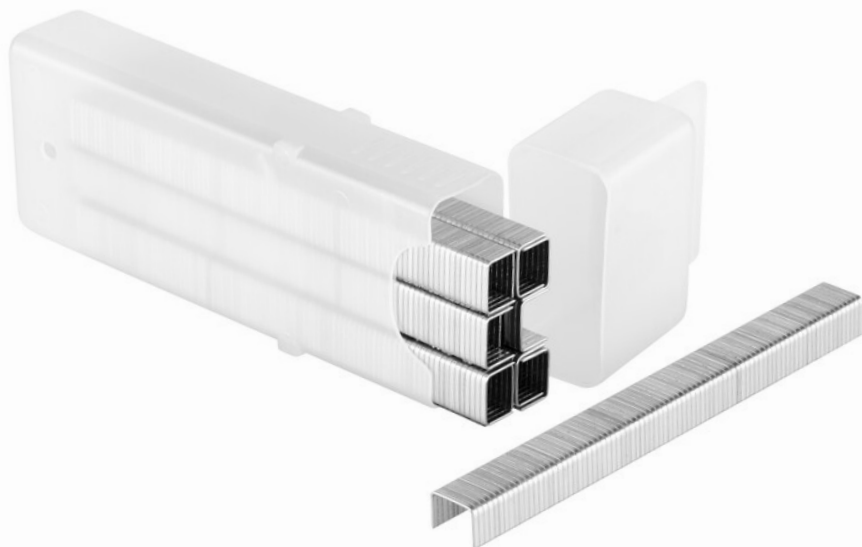

Tipo G Type G

STANLEY

8mm
1000Un



10mm
1000Un



12mm
1000Un



14mm
1000Un



N. Ref.	Descrição	Marca	Quant. Caixa
TRA705T	AGRAFO TIPO G (4/11/140) 8MM	STANLEY	1
TRA706T	AGRAFO TIPO G (4/11/140) 10MM	STANLEY	1
TRA708T	AGRAFO TIPO G (4/11/140) 12MM	STANLEY	1
TRA709T	AGRAFO TIPO G (4/11/140) 14MM	STANLEY	1

ALICATE DE REBITAR
REMACHADORA
RIVETING PLIER

STANLEY



Rebites: 2, 3, 4, 5mm
Remanches: 2, 3, 4, 5mm
Rivets: 2, 3, 4, 5mm



N. Ref.	Descrição	Marca	Quant. Caixa
6-MR55	ALICATE REBITAR-STA-6-MR55	STANLEY	1

ADAPTADOR PARA PARAFUSO PHILLIPS
ADAPTADOR DE TORNILLO PHILLIPS
PHILLIPS SCREW ADAPTER

STANLEY

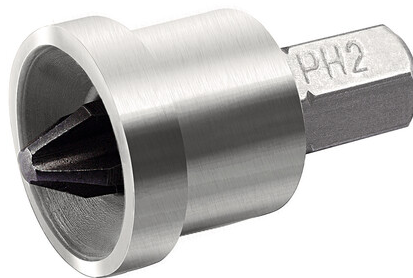

PH2

N. Ref.	Descrição	Marca	Quant. Caixa
STHTO-16137	PH2 PHILLIPS ADAPT P/PARAFUSO	STANLEY	1/12

X-ACTO SM
CÚTER SM
SNAP-OFF SM KNIFE

STANLEY



1 Lâmina
1 Cuchilla
1 Blade



9mm



1 Lâmina
1 Cuchilla
1 Blade



18mm



N. Ref.	Descrição	Marca	Quant. Caixa
0-10-150	X-ACTO SM 9MM	STANLEY	1
0-10-151	X-ACTO SM 18MM	STANLEY	1/12

X-ATO INTERLOCK
CÚTER INTERLOCK
INTERLOCK SNAP-OFF KNIFE

Roda Bloqueio
Rueda Bloqueo
Locking Wheel

STANLEY



1 Lâmina
1 Cuchilla
1 Blade



9mm



1 Lâmina
1 Cuchilla
1 Blade



18mm



N. Ref.	Descrição	Marca	Quant. Caixa
0-10-095	X-ACTO INTERLOCK 9MM	STANLEY	1
0-10-018	X-ACTO INTERLOCK 18MM	STANLEY	1/12

STANLEY

X-ACTO FATMAX CÚTER FATMAX 9MM SNAP-OFF FATMAX KNIFE

6 Lâminas
6 Cuchillas
6 Blades



9mm



6 Lâminas
6 Cuchillas
6 Blades



18mm



4 Lâminas
4 Cuchillas
4 Blades



25mm



N. Ref.	Descrição	Marca	Quant. Caixa
0-10-475	X-ACTO FATMAX 9MM	STANLEY	1
0-10-481	X-ACTO FATMAX 18MM	STANLEY	1
0-10-486	X-ACTO FATMAX 25MM	STANLEY	1

X-ACTO CORTE LATERAL CÚTER CORTE LATERAL SIDE CUT SNAP-OFF KNIFE

Roda Bloqueio
Rueda Bloqueo
Locking Wheel

1 Lâmina
1 Cuchilla
1 Blade



Corte Lateral
Corte lateral
Side Cut

18mm



N. Ref.	Descrição	Marca	Quant. Caixa
FMHT10592	X-ACTO FATMAX 18MM CORTE LATERAL	STANLEY	1

RASPA VIDROS
RASPA VIDROS
GLASS SCRAPER

Plástico
Plastic



1 Lâmina



STANLEY



N. Ref.	Descrição	Marca	Quant. Caixa
0-28-590	RASPA VIDROS DE PLÁSTICO		5

RASPA VIDROS
RASCAVIDRIOS
GLASS SCRAPER



5 Lâminas



STANLEY

N. Ref.	Descrição	Marca	Quant. Caixa
0-28-217	RASPA VIDROS BIMATERIAL 5 LAMI	STANLEY	5

FACA ABS
CUCHILLO ABS
ABS KNIFE



1 Lâmina



STANLEY



N. Ref.	Descrição	Marca	Quant. Caixa
0-10-088	FACA ABS LAMINA DE RECOLHA	STANLEY	1

FACA DE ALCATIFA
CUCHILLO DE ALFOMBRA
CARPET KNIFE

3 Lâminas
3 Cuchillas
3 Blades



N. Ref.	Descrição	Marca	Quant. Caixa
2-10-099	FACA ALCATIFA-STA-RETRACTIL	STANLEY	12

STANLEY

FACA SKELETON
CUCHILLO SKELETON
SKELETON KNIFE

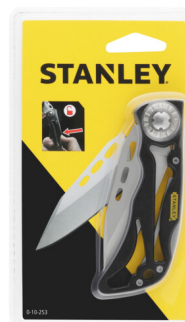

N. Ref.	Descrição	Marca	Quant. Caixa
0-10-253	FACA SKELETON	STANLEY	1

STANLEY

FACA QUICKSLIDE SPORT
CUCHILLO QUICKSLIDE SPORT
QUICKSLIDE SPORT KNIFE



2IN1

N. Ref.	Descrição	Marca	Quant. Caixa
0-10-813	FACA QUICKSLIDE SPORT	STANLEY	1

STANLEY

SUPORE PARA MARTELO
SOPORTE PARA MARTILLO
HAMMER HOLDER

STANLEY



1 Bolso

N. Ref.	Descrição	Marca	Quant. Caixa
STST1-80117	SUPORE PARA MARTELO	STANLEY	1

CINTO DE PELE
CINTURÓN PIEL
LEATHER BELT

STANLEY



N. Ref.	Descrição	Marca	Quant. Caixa
STST1-80119	CINTO PELE STANLEY	STANLEY	1

JOELHEIRAS DURAS
RODILLERAS DURAS
HARD KNEE PADS

STANLEY

UNIVERSAL



N. Ref.	Descrição	Marca	Quant. Caixa
FMST82961	JOELHEIRAS DURAS FATMAX	STANLEY	1

PORTA-FERRAMENTAS
PORTAHERRAMIENTAS
TOOL HOLDER

STANLEY



4 Bolsos

N. Ref.	Descrição	Marca	Quant. Caixa
STST1-80116	PORTA FERRAMENTAS PARA PREGOS	STANLEY	1

PORTA-FERRAMENTAS
PORTAHERRAMIENTAS
TOOL HOLDER

STANLEY



3 Bolsos

N. Ref.	Descrição	Marca	Quant. Caixa
STST1-80114	PORTA FERRAMENTAS PREGO MART.	STANLEY	1

AVENTAL PORTA-FERRAMENTAS
DELANTAL PORTAHERRAMIENTAS
TOOL HOLDER APRON

STANLEY



9 Bolsos

N. Ref.	Descrição	Marca	Quant. Caixa
1-96-178	AVENTAL PORTA-FERRAMENTAS 9B	STANLEY	1

PORTA-FERRAMENTAS
PORTAHERRAMIENTAS
TOOL HOLDER

STANLEY



4 Bolsos

N. Ref.	Descrição	Marca	Quant. Caixa
1-96-181	BOLSA PORTA-FERRAMENTAS	STANLEY	1

COLETE PORTA FERRAMENTA
CHALECO PORTAHERRAMIENTA
TOOL HOLDER WAISTCOAT**STANLEY****14 Bolsos**

N. Ref.	Descrição	Marca	Quant. Caixa
FMST1-71181	COLETE PORTA FERRAMENTA FATMAX	STANLEY	1

AVENTAL PORTA-FERRAMENTAS
DELANTAL PORTAHERRAMIENTAS
TOOL HOLDER APRON**STANLEY****11 Bolsos**

N. Ref.	Descrição	Marca	Quant. Caixa
STST1-80113	AVENTAL PORTA-FERRAMENTAS 11B	STANLEY	1

MOCHILA PARA FERRAMENTA
BOLSA DE HERRAMIENTAS
TOOL BACKPACK



15Kg

Medidas / Measures **305x475x185mm**
Contém / Contiene / Contains **19 compartimentos**

N. Ref.	Descrição	Marca	Quant. Caixa
STST1-72335	MOCHILA STANLEY	STANLEY	1

OFICINA MÓVEL
TALLER MÓVIL
MOBILE WORKSHOP

STANLEY**3in1**

Capacidade / Capacidad / Capacity **4.4Kg**

Medidas / Measures **475x630x283mm**

N. Ref.	Descrição	Marca	Quant. Caixa
STST1-80151	OFICINA MOVÉL 3EM1 ESSENCIAL	STANLEY	1

BROCA MULTI-USOS
BROCA MULTI-USOS
MULTI-PURPOSE DRILL BIT

Haste hexagonal
Hexagonal rod



4mm



5mm



6mm



8mm



10mm



STANLEY



N. Ref.	Descrição	Marca	Quant. Caixa
STA53197	BROCA MULTI-USOS HASTE HX 4MM	STANLEY	1
STA53202	BROCA MULTI-USOS HASTE HX 5MM	STANLEY	1
STA53207	BROCA MULTI-USOS HASTE HX 6MM	STANLEY	1
STA53212	BROCA MULTI-USOS HASTE HX 8MM	STANLEY	1
STA53217-QZ	BROCA MULTI-USOS HASTE HX 10MM	STANLEY	1

BROCA PARA VIDRO E CERÂMICA
BROCA PARA VIDRIO Y CERÁMICA
GLASS AND CERAMIC DRILL

para Vidro e Cerâmica
para Vidrio y Cerámica
for Glass and Ceramic



3mm



4mm



5mm



6mm



8mm



10mm



12mm



STANLEY



N. Ref.	Descrição	Marca	Quant. Caixa
STA53252	BROCAS P/VIDRO E CERAMICA 3MM	STANLEY	1
STA53227	BROCAS P/VIDRO E CERAMICA 4MM	STANLEY	1
STA53232	BROCAS P/VIDRO E CERAMICA 5MM	STANLEY	1
STA53237	BROCAS P/VIDRO E CERAMICA 6MM	STANLEY	1
STA53242	BROCAS P/VIDRO E CERAMICA 8MM	STANLEY	1
STA53247	BROCAS P/VIDRO E CERAMICA 10MM	STANLEY	1
STA53377-QZ	BROCAS P/VIDRO E CERAMICA 12MM	STANLEY	1

MADER®

HAND TOOLS

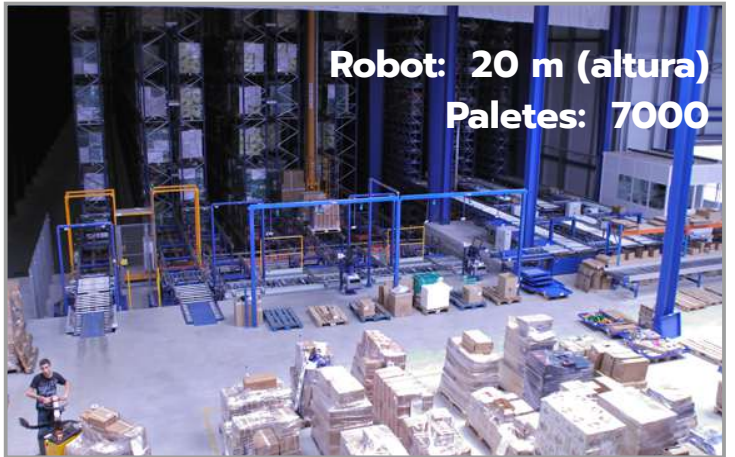

Robot: 20 m (altura)
Paletes: 7000



Show Room: 800 m²



Desde 1971
Área : 23.000 m²

MADER®

TRABALHA COMO UM **PROFISSIONAL**

M MADER®

M MADEIRA®
MADEIRA & MADEIRA

Zona Industrial da Pedrulha, lote 13
3050-183 Casal Comba | Mealhada, Portugal
Apartado 100, 3050-901 Mealhada

T. +351 231 200 200
F. +351 231 200 201
Tm. +351 919 854 879
geral@mader.pt
www.mader.pt



PME líder'22



Management
System
ISO 9001:2015

www.tuv.com
ID: 9105073648